



**Quality building tools
produced by Kaufmann**
2023 – 2026





Kaufmann GmbH
Tel. +43 5522 73 822
Fax +43 5522 72 404
www.kaufmann-tools.at
office@kaufmann-tools.at

EAN-Code
90 02648

Fliesenschneidmaschinen Tile cutting machines Machines coupe-carreaux	8 – 26
Steintrennsägen Stone saws Scies de chantier	27 – 32
Maurerkellen / Spachteln Mason trowels / spatulas Truelles de maçon / spatules	33 – 41
Zahnkellen / Glättkellen / Aufziehglätten / Steinholzglätten Notched trowels / smoothing trowels / application trowels / flooring trowels Truelles dentées / platoirs / taloches / platoirs flamands	42 – 58
Rührquirle Mixing paddles Mélangeurs	59 – 62
Feinsteinzeug / Steckdosenschneider / Fliesenbohrgeräte Porcelain stoneware drill / power socket cutter / tile drilling tools Foret grès-cérame / scies-cloches / outils de forage pour carreaux	63 – 64
Fasenhobel / Deckensägen / Raspelhobel / Gipserhobel Router / ceiling saw / planes Rabots / scie de plafond	65 – 67
Schlagschnurgeräte Chalk line marker Cordeaux traceur	68 – 70
Verkaufsstände / Firmendaten / Zahnungen Display stand / company data / notches Présentoir / références / dentures	71 – 87

EN Index of contents



Kaufmann GmbH
 Tel. +43 5522 73 822
 Fax +43 5522 72 404
 www.kaufmann-tools.at
 office@kaufmann-tools.at

EAN-Code
 90 02648

A			
Accessory box for TopLine	26	Tungsten carbide cutting wheels	24 - 25
Angle bar for TopLine	21	U	
Angle for stone saws	32	Uniflies tile cutting machine	8
Angle for tile cutting machines	21	W	
Anti-slip protection for TopLine	23	Wall plane	66
Application trowels	47 - 48, 56 - 57	Water pump for stone saws	32
		Wheels for stone saws	32
B		Wheels for worktable TopLine	20
Breaker for mosaic for TopLine	22	Worktable for TopLine	20
C			
Cat's tongue trowel	38		
Ceiling saw	65		
Chalk line markers	68 - 70		
Classic stone saw	29 - 30		
Company data	85		
Corner trowels	40 - 41		
Cutting discs for stone saws	31		
Cutting wheel holder for TopLine	22		
Cutting wheels for tile cutting machines	24 - 25		
D			
Darby float	58		
Diamond cutting discs for stone saws	31		
Display stand for tile cutting machines	71		
Drywall scraper	41		
Drywall trowel	53		
E			
Exploded drawings	72 - 84		
F			
Flooring trowels	54 - 55		
H			
Handle for Floorbest trowel	46		
Hole cutters	63 - 64		
Hole device	63		
J			
Joint scraper	39		
M			
Mason trowels	33 - 35		
Master chalk line marker	68 - 69		
Maxiflies tile cutting machine	9		
Mixing paddles	59 - 62		
N			
Notched blades for Floorbest trowel	46		
Notches	86 - 87		
P			
Planers	66 - 67		
Plasterer trowel	36		
Plaster-saws	65		
Pointed trowels	38		
Pool trowel	53		
Power socked cutter	64		
R			
Release lever with lock washer for TopLine	22		
Routers	65		
S			
Safety pads for TopLine	23		
Side table for stone saws	32		
Smoothing trowels	42 - 46, 49 - 54		
Solid tile-hole borer	63		
Spatulas	37, 39		
SpeedMaster chalk line marker	70		
Spindles for tile cutting machines	23		
Stirrers	59 - 62		
Stone saws	27 - 32		
Superflies tile cutting machine	10		
Superline tile cutting machine	19		
T			
Tile cutting machines	8 - 19		
Tile-hole borer	63		
Tile-hole device	63		
Tiler trowels	39		
Titan stone saw	27 - 28		
TopLine tile cutting machines	11 - 18		

FR Index alphabétique



Kaufmann GmbH
Tel. +43 5522 73 822
Fax +43 5522 72 404
www.kaufmann-tools.at
office@kaufmann-tools.at

EAN-Code
90 02648

A	
Axes pour machines coupe-carreaux	23
B	
Barre angulaire pour TopLine	21
Bouchons antidérapants pour TopLine	23
Box avec accessoires TopLine	26
C	
Classic scie de chantier	29 - 30
Cordeaux traceur	68 - 70
D	
Dentures	86 - 87
Dispositif de perforation pour carreaux	63
Disques pour scies de chantier	31
E	
Equerres pour machines coupe-carreaux	21
Equerres pour scies de chantier	32
L	
Levier de déclenchement pour TopLine	22
M	
Machines coupe-carreaux	8 - 26
Master cordeau traceur	68 - 69
Maxiflies machine coupe-carreaux	9
Mélangeurs	59 - 62
Molettes pour machines coupe-carreaux	24 - 25
P	
Platoirs	49 - 55
Poignée pour plateau multi-lames	46
Pompe à eau pour scies de chantier	32
Porte-molette pour TopLine	22
Présentoir pour machines coupe-carreaux	71
R	
Rabots	65 - 67
Racloir placoplâtre	41
Références	85
Revêtements de protection pour TopLine	23
Roulettes pour table de travail pour TopLine	20
Roulettes pour scies de chantier	32
S	
Scie de plafond/stucateur	65
Scies de chantier	27 - 32
Scies-cloches	64
Séparateur pour mosaïque pour TopLine	22
Solid perce-carreaux	63
SpeedMaster cordeau traceur	70
Superflies machine coupe-carreaux	10
Superline machine coupe-carreaux	19
T	
Table de travail pour TopLine	20
Table latérale pour scies de chantier	32
Taloches	56 - 58
Taloches dentées	47 - 48
Titan scie de chantier	27 - 28
TopLine machines coupe-carreaux	11 - 18
Truelles inox	33 - 41
U	
Uniflies machine coupe-carreaux	8
V	
Vues éclatées	72 - 84

DE Artikelnummernverzeichnis
EN Index of item numbers
FR Index numérique



Kaufmann GmbH
 Tel. +43 5522 73 822
 Fax +43 5522 72 404
 www.kaufmann-tools.at
 office@kaufmann-tools.at

EAN-Code
 90 02648

10.406.01	21	11.175.00	61	17.054.12	42	21.030.04	54
10.406.03	21	11.512.00	60	17.055.04	42	21.030.05	54
10.406.04	21	11.512.18	60	17.055.06	42	21.030.06	54
10.406.05	21	11.513.00	60	17.055.08	42	21.033.01	55
10.406.13	21	11.516.00	60	17.055.10	42	21.033.02	55
10.406.14	21	11.536.00	62	17.055.12	42	21.033.03	55
10.422.01	23	11.537.00	62	17.080.10	45	21.033.04	55
10.438.02	22	11.562.00	59	17.080.12	45	21.035.01	54
10.443.01	22	11.575.00	61	17.260.01	46	21.035.02	54
10.444.01	23	11.586.00	60	17.270.06	46	21.035.03	54
10.445.01	21	11.588.00	61	17.270.08	46	21.035.04	54
10.445.02	21	11.588.10	61	17.270.10	46	21.035.05	54
10.445.03	21	11.589.00	61	17.270.11	46	21.035.06	54
10.447.01	19	11.589.10	61	17.270.16	46	21.040.01	55
10.447.02	19	11.590.00	61	17.300.06	47	21.040.02	55
10.448.01	26	12.312.20	63	17.300.08	47	21.040.03	55
10.448.02	26	12.465.02	63	17.300.10	47	21.040.05	55
10.449.01	22	12.465.03	63	17.300.11	47	21.050.01	51
10.500.01	20	12.499.01	63	17.300.12	47	21.051.01	51
10.501.01	20	17.014.04	44	17.424.03	48	21.067.01	49
10.502.01	20	17.014.06	44	17.424.04	48	21.068.01	49
10.503.01	20	17.014.08	44	17.424.06	48	21.068.04	49
10.725.01	9	17.014.10	44	17.424.08	48	21.069.01	49
10.760.01	10	17.014.12	44	17.424.10	48	21.072.01	49
10.830.02	11	17.016.03	44	17.424.11	48	21.073.01	53
10.830.03	11	17.016.04	44	17.424.12	48	21.078.01	52
10.830.04	11	17.016.06	44	17.424.15	48	21.078.04	52
10.831.02	11	17.016.08	44	17.424.18	48	21.078.05	52
10.833.05	12	17.016.10	44	17.424.26	48	21.079.02	52
10.845.02	15	17.016.12	44	17.424.51	48	21.120.02	49
10.845.03	15	17.016.15	44	17.424.52	48	21.121.03	49
10.845.04	15	17.016.37	44	17.424.53	48	21.712.01	57
10.845.06	16	17.016.39	44	17.424.61	48	21.775.02	54
10.845.07	17	17.016.51	44	17.425.06	47	21.775.04	54
10.845.14	15	17.016.52	44	17.425.08	47	21.775.05	54
10.845.16	16	17.016.53	44	17.425.10	47	21.775.06	54
10.845.17	17	17.016.61	44	17.426.06	47	21.790.01	53
10.846.02	15	17.017.03	44	17.426.08	47	21.790.02	53
10.848.05	16	17.017.04	44	17.426.10	47	21.790.03	53
10.848.15	16	17.017.06	44	17.483.03	48	21.790.06	53
10.850.02	18	17.017.08	44	17.483.04	48	21.827.02	57
10.850.03	18	17.017.10	44	17.483.06	48	25.110.01	66
10.850.04	18	17.017.11	44	17.483.08	48	25.140.00	65
10.850.05	18	17.017.12	44	17.483.10	48	25.143.00	65
10.851.02	13	17.017.15	44	17.483.12	48	25.146.00	65
10.852.02	13	17.017.16	44	17.483.54	48	25.160.00	65
10.852.03	13	17.017.20	44	17.483.61	48	25.160.24	65
10.852.04	13	17.017.51	44	17.980.04	46	25.161.00	65
10.852.14	13	17.017.52	44	17.980.06	46	25.161.24	65
10.852.15	14	17.017.53	44	17.980.08	46	26.100.01	64
10.860.02	19	17.017.54	44	17.980.10	46	26.100.02	64
10.860.04	19	17.017.61	44	17.980.12	46	26.110.01	64
10.860.05	19	17.018.03	44	21.001.06	50	26.110.02	64
10.909.01	8	17.018.04	44	21.004.01	50	40.120.01	68
10.970.51	23	17.018.06	44	21.004.02	50	40.120.02	68
10.970.53	23	17.018.08	44	21.007.01	50	40.120.03	69
10.970.55	23	17.018.10	44	21.007.02	50	40.123.01	68
10.970.57	23	17.018.12	44	21.007.04	50	40.123.02	68
10.980.01	25	17.032.04	43	21.010.01	50	40.130.01	70
10.980.02	25	17.032.06	43	21.010.02	50	40.130.02	70
10.980.13	25	17.032.08	43	21.010.05	50	40.131.01	70
10.980.14	25	17.032.10	43	21.011.01	50	42.058.01	36
10.980.21	24	17.033.04	43	21.011.02	50	42.058.02	36
10.980.22	24	17.033.06	43	21.011.13	49	42.058.03	36
10.980.25	24	17.033.08	43	21.012.01	52	42.058.50	39
10.980.27	24	17.033.10	43	21.013.01	52	42.060.01	37
10.980.29	24	17.036.04	43	21.016.01	56	42.060.02	37
11.001.00	59	17.036.06	43	21.017.01	56	42.060.03	37
11.007.00	59	17.036.08	43	21.018.01	56	42.060.04	37
11.009.00	59	17.036.10	43	21.018.03	56	42.060.05	37
11.010.00	59	17.037.04	43	21.018.04	56	42.060.06	37
11.011.00	60	17.037.06	43	21.019.01	56	42.060.07	37
11.012.00	60	17.037.08	43	21.019.03	56	42.060.10	37
11.013.00	60	17.037.10	43	21.019.20	56	42.061.05	39
11.020.00	60	17.037.12	43	21.019.27	58	42.061.06	39
11.036.00	62	17.037.15	43	21.020.01	57	42.063.01	38
11.037.00	62	17.037.20	43	21.020.02	57	42.063.02	38
11.039.00	60	17.037.52	43	21.021.01	57	42.064.01	40
11.056.00	59	17.054.04	42	21.023.02	53	42.064.02	40
11.058.00	59	17.054.06	42	21.030.01	54	42.064.03	40
11.060.00	59	17.054.08	42	21.030.02	54	42.065.01	40
11.062.00	59	17.054.10	42	21.030.03	54	42.065.02	40



Kaufmann GmbH
Tel. +43 5522 73 822
Fax +43 5522 72 404
www.kaufmann-tools.at
office@kaufmann-tools.at

EAN-Code
90 02648.....

42.065.03	40	93.982.02	31
42.068.06	37	93.984.02	31
42.084.01	38	93.992.02	31
42.085.01	39	93.993.02	31
42.085.02	39	93.994.04	31
42.085.04	39	93.996.02	31
42.085.06	39	93.998.02	31
42.087.02	35		
42.087.03	35		
42.111.01	66		
42.111.50	66		
42.113.01	41		
42.113.02	41		
42.113.03	41		
42.113.04	41		
42.113.05	41		
42.114.01	41		
42.114.02	41		
42.114.03	41		
42.114.04	41		
42.114.05	41		
42.117.01	35		
42.118.01	35		
42.119.01	35		
42.304.01	41		
42.558.01	36		
42.558.02	36		
42.558.03	36		
42.560.01	37		
42.560.02	37		
42.560.03	37		
42.560.04	37		
42.560.05	37		
42.560.06	37		
42.560.07	37		
42.560.08	37		
42.560.10	37		
42.563.01	38		
42.563.02	38		
42.564.01	40		
42.564.02	40		
42.565.01	41		
42.565.02	41		
43.057.01	33		
43.057.03	33		
43.059.01	33		
43.059.03	33		
43.068.02	34		
43.556.01	34		
43.557.01	33		
43.557.03	33		
43.559.01	34		
43.559.03	34		
45.637.01	67		
71.060.02	71		
93.220.04	30		
93.220.06	30		
93.220.08	30		
93.220.09	30		
93.240.04	30		
93.240.06	30		
93.240.08	30		
93.240.09	30		
93.330.04	28		
93.330.05	28		
93.330.07	28		
93.330.09	28		
93.330.11	28		
93.340.04	28		
93.340.05	28		
93.340.07	28		
93.340.09	28		
93.340.11	28		
93.962.03	32		
93.963.01	32		
93.963.02	32		
93.963.03	32		
93.965.01	32		
93.965.02	32		
93.969.01	32		
93.977.02	31		
93.980.02	31		



Kaufmann GmbH
 Tel. +43 5522 73 822
 Fax +43 5522 72 404
 www.kaufmann-tools.at
 office@kaufmann-tools.at

EAN-Code
 90 02648



DE Fliesenschneidmaschine UNIFLIES für den Heimwerker

für Mosaik, Wand- und Bodenplatten bis 12 mm • aus Alu-Druckguss • hohe Anschlagleiste mit Diagonalschnittkerbe, Millimeter- und Zollskala • verstellbarer Anschlagwinkel für 90° • Hartmetall-Schneidrad Ø 14 mm • robust und handlich

EN Tile cutting machine UNIFLIES for the do-it-yourselfer

for mosaic, tiles and slabs up to 12 mm • made of die-cast aluminium • high stop with notch for diagonal cuts, millimetre and inch scale • adjustable cutting guide for 90° • tungsten carbide cutting wheel Ø 14 mm • robust and handy

FR Machine coupe-carreaux UNIFLIES pour le bricoleur

pour mosaïques, carreaux muraux et de sol jusqu'à 12 mm • en aluminium coulé sous pression • butée surélevée et graduée en millimètre et en pouce, avec entaille pour la coupe diagonale • équerre réglable pour 90° • molette au carbure de tungstène Ø 14 mm • robuste et maniable

10.909.01	440 mm	310x310 mm	12 mm	10 mm	1,95 kg	9	00909 5

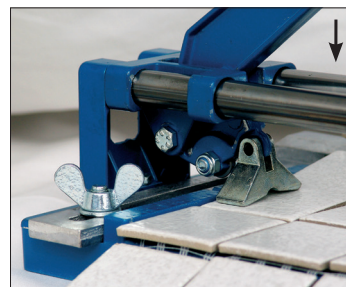
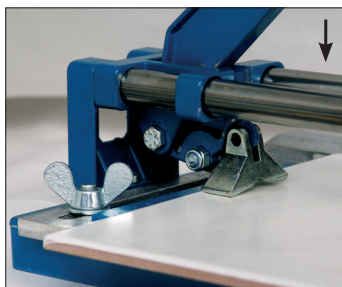
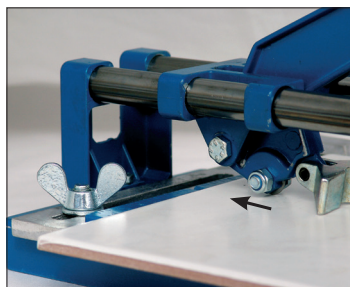



Kaufmann GmbH
 Tel. +43 5522 73 822
 Fax +43 5522 72 404
 www.kaufmann-tools.at
 office@kaufmann-tools.at

EAN-Code
 90 02648

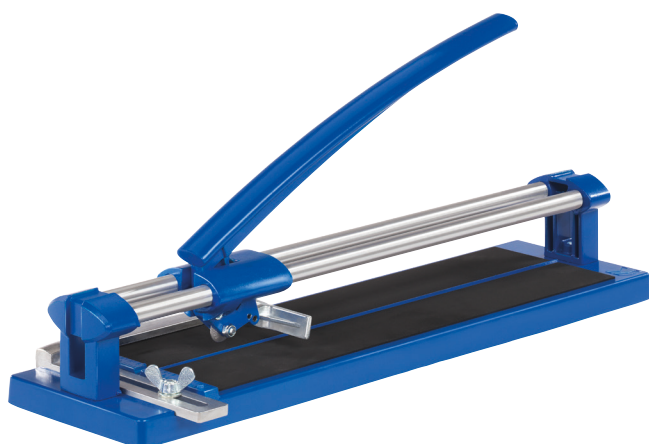

DE Fliesenschneidmaschine MAXIFLIES für den Heimwerker mit hohen Ansprüchen

für Mosaik, Wand- und Bodenplatten bis 16 mm • aus Alu-Druckguss • geschliffene Führungsstangen • hohe Anschlagleiste mit Diagonalschnittkerbe, mit Millimeter- und Zollskala • verstellbarer Anschlagwinkel für 90° • arretierbare Brechvorrichtung für optimale Sicht auf das Schneidgut • Hartmetall-Schneidrad Ø22 mm

EN Tile cutting machine MAXIFLIES for the do-it yourselfer with high demands

for mosaic, tiles and slabs up to 16 mm • made of die-cast aluminium • polished guide bars • high stop with notch for diagonal cuts, with millimetre and inch scale • adjustable angle for 90° • lockable breaking device for an optimal view on the tile • tungsten carbide cutting wheel Ø22 mm

FR Machine coupe-carreaux MAXIFLIES pour le bricoleur performant

pour mosaïques, carreaux muraux et de sol jusqu'à 16 mm • en aluminium coulé sous pression • barres porteuses polies • butée surélevée et graduée en millimètre et en pouce avec entaille pour la coupe en diagonale • équerre réglable pour 90° • dispositif de casse avec système de blocage pour une vision optimale sur la molette de coupe • molette au carbure de tungstène Ø22 mm

10.725.01	410 mm	290x290 mm	16 mm	12 mm	4,0 kg	6	00725 1



Kaufmann GmbH
 Tel. +43 5522 73 822
 Fax +43 5522 72 404
 www.kaufmann-tools.at
 office@kaufmann-tools.at

EAN-Code
 90 02648

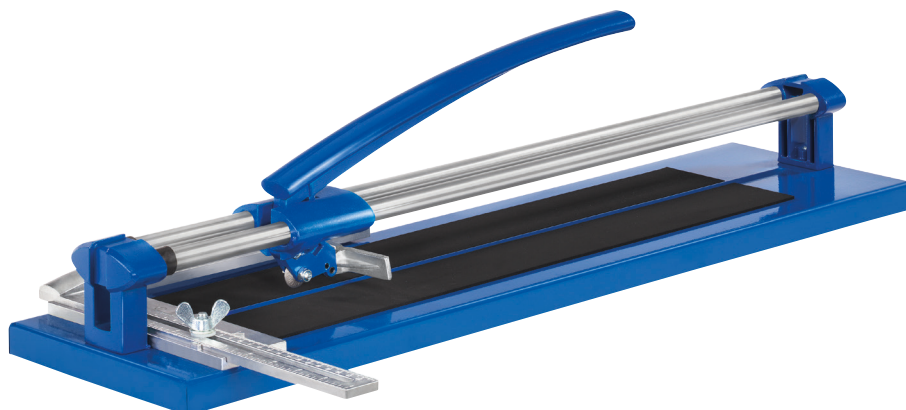

DE Fliesenschneidmaschine SUPERFLIES für den Heimwerker mit hohen Ansprüchen

für Mosaik, Wand- und Bodenplatten bis 16 mm • robuste Alu/Stahlkonstruktion • geschliffene Führungsstangen
 • hohe Anschlagleiste mit Diagonalschnittkerbe, mit Millimeter- und Zollskala • verstellbarer Anschlagwinkel für 90° und 45° • arretierbare Brechvorrichtung für optimale Sicht auf das Schneidgut • Hartmetall-Schneidrad Ø22 mm

EN Tile cutting machine SUPERFLIES for the do-it yourselfer with high demands

for mosaic, tiles and slabs up to 16 mm • robust construction made of die-cast aluminium and steel • polished guide bars
 • high stop with notch for diagonal cuts, with millimetre and inch scale • adjustable angle for 90° and 45°
 • lockable breaking device for an optimal view on the tile • tungsten carbide cutting wheel Ø22 mm

FR Machine coupe-carreaux SUPERFLIES pour le bricoleur performant

pour mosaïques, carreaux muraux et de sol jusqu'à 16 mm • construction robuste en aluminium et acier • barres porteuses polies
 • butée surélevée et graduée en millimètre et en pouce avec entaille pour la coupe en diagonale
 • équerre réglable pour 90° et 45° • dispositif de casse avec système de blocage pour une vision optimale sur la molette de coupe • molette au carbure de tungstène Ø22 mm

10.760.01	600mm	420x420mm	16mm	12mm	7,4kg	2	16790 0

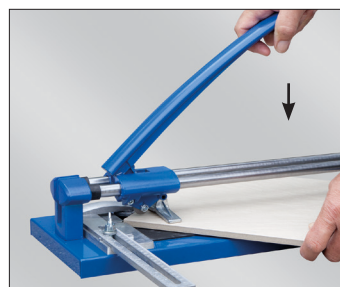
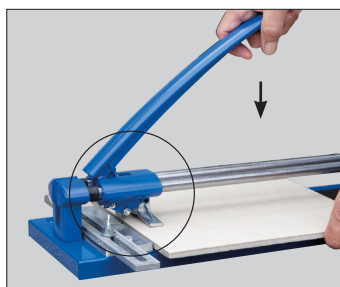



Kaufmann GmbH
 Tel. +43 5522 73 822
 Fax +43 5522 72 404
 www.kaufmann-tools.at
 office@kaufmann-tools.at

EAN-Code
 90 02648

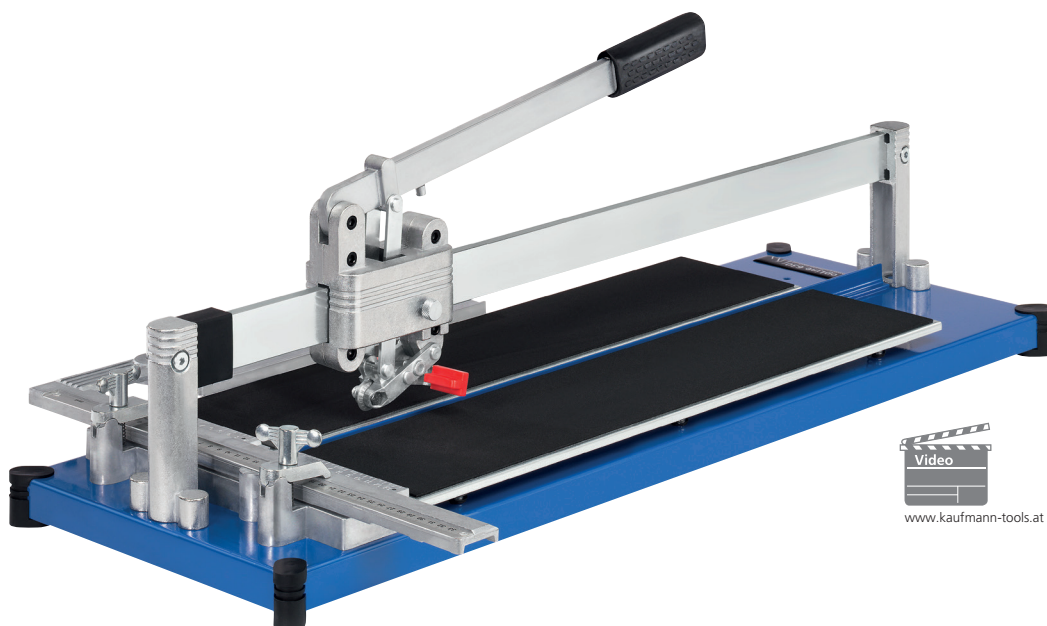

www.kaufmann-tools.at

DE Fliesenschneidmaschine TOPLINE STANDARD für den professionellen Fliesenleger

für Fliesen, Bodenplatten und Mosaik aus Steingut, Steinzeug, Feinsteinzeug und Glas • Schneidrichtung zum Anschlagwinkel • solide Führungsstange für genaue Schnitte • staubgeschützte und genaue Kugellagerführung (wartungsfrei) • verstellbarer Anschlagwinkel für 90° und 45° mit 340 mm Skala und Trapezführung • arretierbare Brechvorrichtung • Brechvorrichtung mit hoher Druckkraft bis 1000 kg und PVC-Schutzschuhen • gefederte Auflageflächen mit rutschfestem Zellkautschukbelag • robuste Grundplatte aus Stahl • PVC-Füße mit Rutschsicherung, verhindern Kratzer oder Spuren bei bestehender Verfliesung • Hartmetall-Schneidrad Ø22 mm PROFI • Transport-sicherung für Führungskopf

EN Tile cutting machine TOPLINE STANDARD for the professional tiler

for tiles, slabs and mosaics made of earthenware, stoneware, porcelain stoneware and glass • cutting direction towards the angle • solid guide bar for exact cuts • dust-protected and precise ball bearing cutting head (maintenance free) • adjustable angle for 90° and 45° with 340 mm scale and trapezium guidance • lockable breaking device • breaking device with high compressive force up to 1000 kg and PVC safety pads • spring supported overlay with anti-skid cellular rubber covering • robust bottom made of steel • PVC feet with anti-slip protection, protect against scratches on finished tile • tungsten carbide cutting wheel Ø22 mm PROFI • lockable cutting head for safe transport

FR Machine coupe-carreaux TOPLINE STANDARD pour le carreleur professionnel

pour les carrelages, dalles et mosaïques en faïence, grès, grès-cérame et verre • direction de coupe vers l'équerre • barre porteuse renforcée pour coupes exactes • tête coulissante équipée de roulements à bille précis et protégée contre la poussière (sans entretien) • équerre réglable pour 90° et 45° avec graduation de 340 mm et guidage trapézoïdale • dispositif de casse avec système de blocage • dispositif de casse permettant d'exercer une plus forte pression jusqu'à 1000 kg et avec revêtement de protection en PVC • surfaces d'appui montées sur ressorts avec semelles antidérapantes en caoutchouc cellulaire • socle robuste en acier • pieds en PVC avec bouchons antidérapants, évitant des traces sur le carrelage déjà posé • molette au carbure de tungstène Ø22 mm PROFI • dispositif de fixation de la tête de guidage pour le transport

Ref.						
10.831.02	630 mm	440x440 mm	18 mm	16 mm	14,2 kg	17616 2
10.830.03	720 mm	500x500 mm	18 mm	16 mm	16,1 kg	16869 3
10.830.04	920 mm	650x650 mm	18 mm	16 mm	15,2 kg	16870 9

LIGHT - Grundplatte aus Aluminium / bottom made of aluminium / socle en aluminium

10.830.02	630 mm	440x440 mm	18 mm	16 mm	11,7 kg	16840 2
-----------	--------	------------	-------	-------	---------	---------



Kaufmann GmbH
 Tel. +43 5522 73 822
 Fax +43 5522 72 404
 www.kaufmann-tools.at
 office@kaufmann-tools.at

EAN-Code
 90 02648



DE Fliesenschneidmaschine TOPLINE STANDARD mit 2 Führungsschienen





solide Doppelführung für genaue Schnitte • Seitenauflegeverbreiterung • Transporträder • technische Daten siehe TopLine Standard auf Seite 15

EN Tile cutting machine TOPLINE STANDARD with 2 guide rails

solid double guidance for exact cuts • side supporting surfaces • wheels for transport • technical details see TopLine Standard on page 15

FR Machine coupe-carreaux TOPLINE STANDARD avec 2 rails de guidage

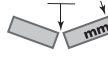
double guidage renforcé pour coupes exactes • appuis latéraux supplémentaires • roulettes de transport • caractéristiques techniques voir TopLine Standard page 15

Ref.						
10.833.05	1250 mm	880x880 mm	18 mm	16 mm	23,0 kg	18051 0

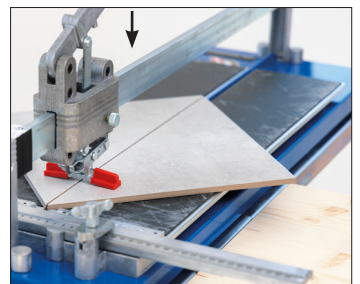
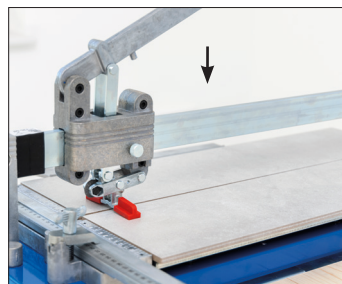
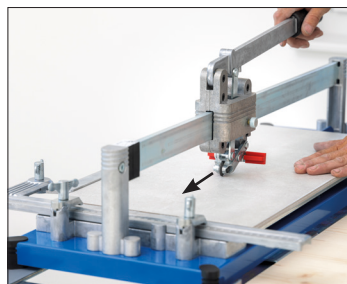



Kaufmann GmbH
 Tel. +43 5522 73 822
 Fax +43 5522 72 404
 www.kaufmann-tools.at
 office@kaufmann-tools.at

EAN-Code
 90 02648



www.kaufmann-tools.at

DE Fliesenschneidmaschine TOPLINE ROCK für den professionellen Fliesenleger

für Fliesen, Bodenplatten und Mosaik aus Steingut, Steinzeug, Feinsteinzeug und Glas • Schneidrichtung zum Anschlagwinkel • volle Sicht auf das Schneidrad für den Rechtshänder • solide Führungsstange für genaue Schnitte • staubgeschützte und genaue Kugellagerführung (wartungsfrei) • verstellbarer Anschlagwinkel für 90° und 45° mit 340 mm Skala und Trapezführung • arretierbare Brechvorrichtung mit Lösehebel • Brechvorrichtung mit hoher Druckkraft bis 1000 kg und PVC-Schutzschuhen • gefederte Auflageflächen mit rutschfestem Zellkautschukbelag • robuste Grundplatte aus Stahl • PVC-Füße mit Rutschsicherung, verhindern Kratzer oder Spuren bei bestehender Verfliesung • professionelles Hartmetall-Schneidrad Ø22 mm mit TiN-Beschichtung • Seitenauflegeverbreiterung • Tragegriff für bequemes Transportieren • Transportsicherung für Führungskopf

EN Tile cutting machine TOPLINE ROCK for the professional tiler

for tiles, slabs and mosaics made of earthenware, stoneware, porcelain stoneware and glass • cutting direction towards the angle • optimal view of the cutting wheel for the right-hander • solid guide bar for exact cuts • dust-protected and precise ball bearing cutting head (maintenance free) • adjustable angle for 90° and 45° with 340 mm scale and trapezium guidance • lockable breaking device with release lever • breaking device with high compressive force up to 1000 kg and PVC safety pads • spring supported overlay with anti-skid cellular rubber covering • robust bottom made of steel • PVC feet with anti-slip protection, protect against scratches on finished tile • professional tungsten carbide cutting wheel Ø22 mm with TiN-coating • side supporting surfaces • carrying handle for a comfortable transport • lockable cutting head for safe transport

FR Machine coupe-carreaux TOPLINE ROCK pour le carreleur professionnel

pour les carrelages, dalles et mosaïques en faïence, grès, grès-cérame et verre • direction de coupe vers l'équerre • vision optimale sur la molette de coupe pour droitier • barre porteuse renforcée pour coupes exactes • tête cou-lissante équipée de roulements à bille précis et protégée contre la poussière (sans entretien) • équerre réglable pour 90° et 45° avec graduation de 340 mm et guidage trapézoïdale • dispositif de casse avec système de blocage avec levier de déclenchement • dispositif de casse permettant d'exercer une plus forte pression jusqu'à 1000 kg et avec revêtement de protection en PVC • surfaces d'appui montées sur ressorts avec semelles antidérapantes en caoutchouc cellulaire • socle robuste en acier • pieds en PVC avec bouchons antidérapants, évitant des traces sur le carrelage déjà posé • molette professionnelle au carbure de tungstène Ø22 mm avec enduction en TiN • appuis latéraux supplémentaires • poignée pour faciliter le transport • dispositif de fixation de la tête de guidage pour le transport

Ref.						
10.852.02	630 mm	440x440 mm	18 mm	16 mm	15,6 kg	18752 6
10.852.03	720 mm	500x500 mm	18 mm	16 mm	12,9 kg	18753 3
10.852.04	920 mm	650x650 mm	18 mm	16 mm	15,9 kg	18754 0

mit 2 Führungsschienen und Transporträder / with 2 guide rails and wheels for transport / avec 2 rails de guidage et roulettes de transport

10.852.14	920 mm	650x650 mm	18 mm	16 mm	17,6 kg	18756 4
-----------	--------	------------	-------	-------	---------	---------

LIGHT - Grundplatte aus Aluminium / bottom made of aluminium / socle en aluminium

10.851.02	630 mm	440x440 mm	18 mm	16 mm	12,1 kg	18755 7
-----------	--------	------------	-------	-------	---------	---------



Kaufmann GmbH
 Tel. +43 5522 73 822
 Fax +43 5522 72 404
 www.kaufmann-tools.at
 office@kaufmann-tools.at

EAN-Code
 90 02648



DE Fliesenschneidmaschine TOPLINE ROCK mit Doppelwinkel
 solide Doppelführung für genaue Schnitte • 2 verstellbare Anschlagwinkel • optionale Winkelleiste • Transporträder
 • technische Daten siehe TopLine Rock auf Seite 17

EN Tile cutting machine TOPLINE ROCK with double angle
 solid double guidance for exact cuts • 2 adjustable angles • optional angle bar • wheels for transport • technical details see TopLine Rock on page 17

FR Machine coupe-carreaux TOPLINE ROCK avec double équerres
 double guidage renforcé pour coupes exactes • 2 équerres réglables • barre angulaire optionnelle • roulettes de transport • caractéristiques techniques voir TopLine Rock page 17

Ref.						
10.852.15	1250 mm	880x880 mm	18 mm	16 mm	23,3 kg	19001 4

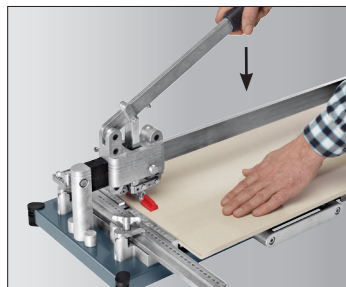



Kaufmann GmbH
 Tel. +43 5522 73 822
 Fax +43 5522 72 404
 www.kaufmann-tools.at
 office@kaufmann-tools.at

EAN-Code
 90 02648

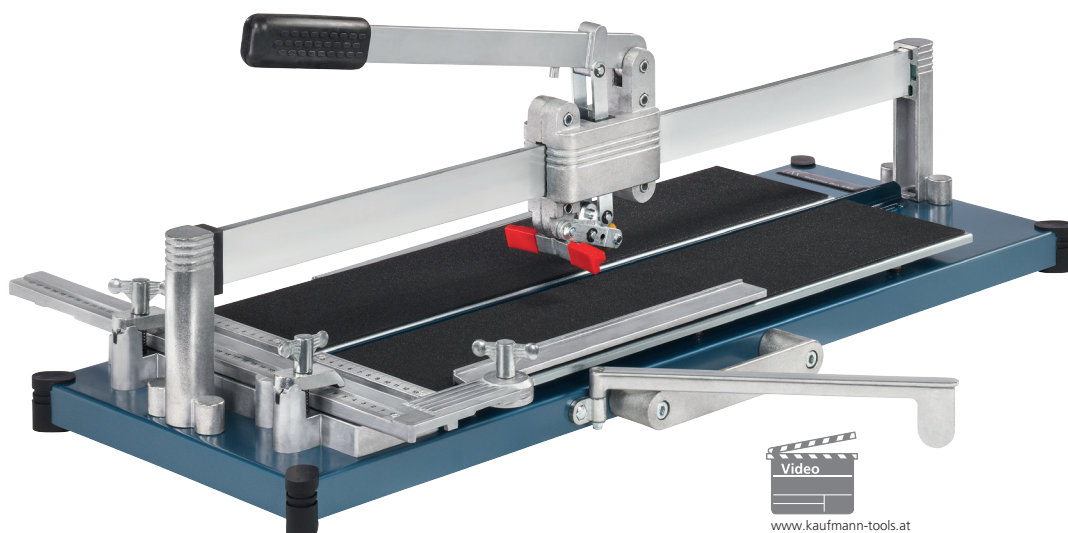

DE Fliesenschneidmaschine TOPLINE PRO für den professionellen Fliesenleger

für Fliesen, Bodenplatten und Mosaik aus Steingut, Steinzeug, Feinsteinzeug und Glas • Schneidrichtung vom Anschlagwinkel beginnend • volle Sicht auf das Schneidrad für den Rechtshänder • solide Führungsstange für genaue Schnitte • staubgeschützte und genaue Kugellagerführung (wartungsfrei) • verstellbarer Anschlagwinkel für 90° und 45° mit 430 mm Skala und Trapezführung • arretierbare Brechvorrichtung mit Lösehebel • Brechvorrichtung mit hoher Druckkraft bis 1000kg und PVC Schutzschuhen • gefederte Auflageflächen mit rutschfestem Zellkautschukbelag • robuste Grundplatte aus Stahl • PVC-Füße mit Rutschsicherung, verhindern Kratzer oder Spuren bei bestehender Verfliesung • professionelles Hartmetall-Schneidrad Ø22 mm mit TiN-Beschichtung • Seitenauflegeverbreiterung • Tragegriff für bequemes Transportieren • Transportsicherung für Führungskopf

EN Tile cutting machine TOPLINE PRO for the professional tiler

for tiles, slabs and mosaics made of earthenware, stoneware, porcelain stoneware and glass • cutting direction starting from the angle • optimal view of the cutting wheel for the right-hander • solid guide bar for exact cuts • dust-protected and precise ball bearing cutting head (maintenance free) • adjustable angle for 90° and 45° with 430mm scale and trapezium guidance • lockable breaking device with release lever • breaking device with high compressive force up to 1000kg and PVC safety pads • spring supported overlay with anti-skid cellular rubber covering • robust bottom made of steel • PVC feet with anti-slip protection, protect against scratches on finished tile • professional tungsten carbide cutting wheel Ø22 mm with TiN-coating • side supporting surfaces • carrying handle for a comfortable transport • lockable cutting head for safe transport

FR Machine coupe-carreaux TOPLINE PRO pour le carreleur professionnel

pour les carrelages, dalles et mosaïques en faïence, grès, grès-cérame et verre • direction de coupe partant de l'équerre • vision optimale sur la molette de coupe pour droitier • barre porteuse renforcée pour coupes exactes • tête coulissante équipée de roulements à bille précis et protégée contre la poussière (sans entretien) • équerre réglable pour 90° et 45° avec graduation de 430 mm et guidage trapézoïdale • dispositif de casse avec système de blocage avec levier de déclenchement • dispositif de casse permettant d'exercer une plus forte pression jusqu'à 1000 kg et avec revêtement de protection en PVC • surfaces d'appui montées sur ressorts avec semelles antidérapantes en caoutchouc cellulaire • socle robuste en acier • pieds en PVC avec bouchons antidérapants, évitant des traces sur le carrelage déjà posé • molette professionnelle au carbure de tungstène Ø22 mm avec enduction en TiN • appuis latéraux supplémentaires • poignée pour faciliter le transport • dispositif de fixation de la tête de guidage pour le transport

Ref.						
10.845.02	630 mm	440x440 mm	18 mm	16 mm	15,6 kg	18652 9
10.845.03	720 mm	500x500 mm	18 mm	16 mm	13,0 kg	18653 6
10.845.04	920 mm	650x650 mm	18 mm	16 mm	16,0 kg	18654 3

mit 2 Führungsschienen und Transporträder / with 2 guide rails and wheels for transport / avec 2 rails de guidage et roulettes de transport

10.845.14	920 mm	650x650 mm	18 mm	16 mm	17,7 kg	18659 8
-----------	--------	------------	-------	-------	---------	---------

LIGHT - Grundplatte aus Aluminium / bottom made of aluminium / socle en aluminium

10.846.02	630 mm	440x440 mm	18 mm	16 mm	12,2 kg	18656 7
-----------	--------	------------	-------	-------	---------	---------



Kaufmann GmbH
 Tel. +43 5522 73 822
 Fax +43 5522 72 404
 www.kaufmann-tools.at
 office@kaufmann-tools.at

EAN-Code
 90 02648

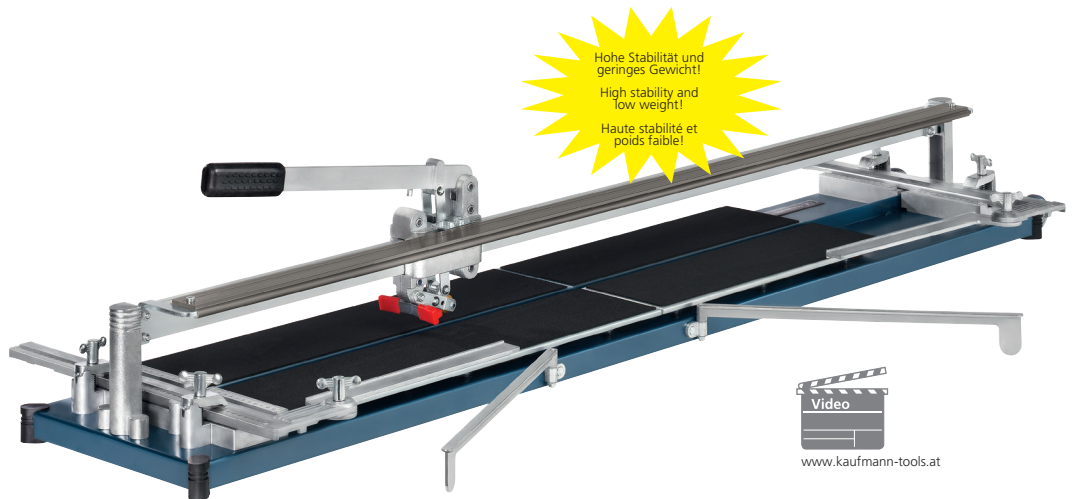

DE Fliesenschneidmaschine TOPLINE PRO mit Doppelwinkel

solide Doppelführung für genaue Schnitte • 2 verstellbare Anschlagwinkel • optionale Winkelleiste • Transporträder
 • technische Daten siehe TopLine Pro auf Seite 19

EN Tile cutting machine TOPLINE PRO with double angle

solid double guidance for exact cuts • 2 adjustable angles • optional angle bar • wheels for transport • technical details see TopLine Pro on page 19

FR Machine coupe-carreaux TOPLINE PRO avec double équerres

double guidage renforcé pour coupes exactes • 2 équerres réglables • barre angulaire optionnelle • roulettes de transport • caractéristiques techniques voir TopLine Pro page 19

Ref.							
10.848.05	1250mm	880x880mm	18mm	16mm	23,4 kg	3,2 kg	18772 4
in Kartonschachtel, in carton box, dans boîte en carton							
10.848.15	1250mm	880x880mm	18mm	16mm	23,4 kg	22,5 kg	18773 1
in Transportkiste aus Holz, in wooden carrier box, dans coffre en bois							
mit 2 langen Winkeln / with 2 long angles / avec 2 équerres longues							
in Kartonschachtel, in carton box, dans boîte en carton							
10.845.16	1550mm	1000x1000mm	18mm	16mm	29,5 kg	3,6 kg	18798 4
in Transportkiste aus Holz, in wooden carrier box, dans coffre en bois							
10.845.06	1550mm	1000x1000mm	18mm	16mm	29,5 kg	24,5 kg	18651 2

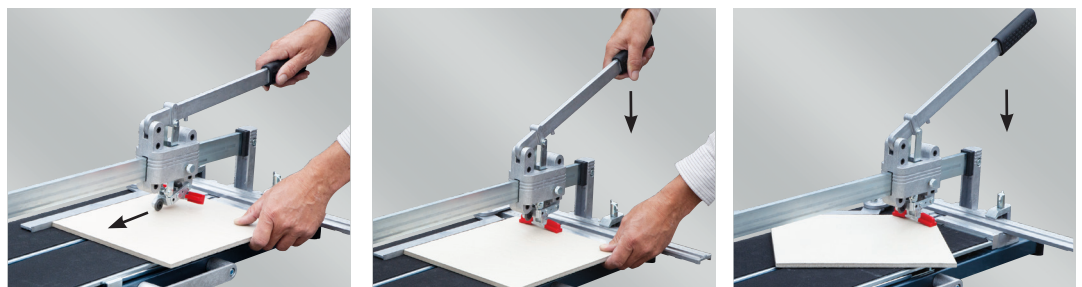



Kaufmann GmbH
 Tel. +43 5522 73 822
 Fax +43 5522 72 404
 www.kaufmann-tools.at
 office@kaufmann-tools.at

EAN-Code
 90 02648



DE Fliesenschneidmaschine TOPLINE PRO mit 2 langen Anschlagwinkeln für den professionellen Fliesenleger

für Fliesen, Bodenplatten und Mosaik aus Steingut, Steinzeug, Feinsteinzeug und Glas • Schneidrichtung vom Anschlagwinkel beginnend • volle Sicht auf das Schneidrad für den Rechtshänder • solide Doppelführung für genaue Schnitte • staubgeschützte und genaue Kugellagerführung (wartungsfrei) • 2 verstellbare Anschlagwinkel für 90° und 45° mit 640 mm und 730 mm Skala und Trapezführung • optionale Winkelleiste • arretierbare Brechvorrichtung mit Lösehebel • Brechvorrichtung mit hoher Druckkraft bis 1000 kg und PVC-Schutzschuhen • gefederte Auflageflächen mit rutschfestem Zellkautschukbelag • robuste Grundplatte aus Stahl • PVC-Füße mit Rutschsicherung, verhindern Kratzer oder Spuren bei bestehender Verfliesung • professionelles Hartmetall-Schneidrad Ø22 mm mit TiN-Beschichtung • Seitenaufweberverbreiterung • Tragegriff für bequemes Transportieren • Transporträder • Transportsicherung für Führungskopf

EN Tile cutting machine TOPLINE PRO with 2 long angles for the professional tiler

for tiles, slabs and mosaics made of earthenware, stoneware, porcelain stoneware and glass • cutting direction starting from the angle • optimal view of the cutting wheel for the right-hander • solid double guidance for exact cuts • dust-protected and precise ball bearing cutting head (maintenance free) • 2 adjustable angles for 90° and 45° with 640 mm and 730 mm scale and trapezium guidance • optional angle bar • lockable breaking device with release lever • breaking device with high compressive force up to 1000 kg and PVC safety pads • spring supported overlay with anti-skid cellular rubber covering • robust bottom made of steel • PVC feet with anti-slip protection, protect against scratches on finished tile • professional tungsten carbide cutting wheel Ø22 mm with TiN-coating • side supporting surfaces • carrying handle for a comfortable transport • wheels for transport • lockable cutting head for safe transport

FR Machine coupe-carreaux TOPLINE PRO avec 2 équerres longues pour le carreleur professionnel

pour les carrelages, dalles et mosaïques en faïence, grès, grès-cérame et verre • direction de coupe partant de l'équerre • vision optimale sur la molette de coupe pour droitier • double guidage renforcé pour coupes exactes • tête coulissante équipée de roulements à bille précis et protégée contre la poussière (sans entretien) • 2 équerres réglables pour 90° et 45° avec graduation de 640 mm et 730 mm et guidage trapézoïdale • barre angulaire optionnelle • dispositif de casse avec système de blocage avec levier de déclenchement • dispositif de casse permettant d'exercer une plus forte pression jusqu'à 1000 kg et avec revêtement de protection en PVC • surfaces d'appui montées sur ressorts avec semelles antidérapantes en caoutchouc cellulaire • socle robuste en acier • pieds en PVC avec bouchons antidérapants, évitant des traces sur le carrelage déjà posé • molette professionnelle au carbure de tungstène Ø22 mm avec enduction en TiN • appuis latéraux supplémentaires • poignée pour faciliter le transport • roulettes de transport • dispositif de fixation de la tête de guidage pour le transport

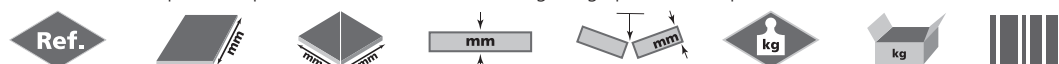

in Kartonschachtel, in carton box, dans boîte en carton
10.845.17 1830 mm 1250 x 1250 mm 18 mm 16 mm 34,2 kg 4,0 kg 19007 6

in Transportkiste aus Holz, in wooden carrier box, dans coffre en bois
10.845.07 1830 mm 1250 x 1250 mm 18 mm 16 mm 34,2 kg 29,0 kg 18779 3



Kaufmann GmbH
 Tel. +43 5522 73 822
 Fax +43 5522 72 404
 www.kaufmann-tools.at
 office@kaufmann-tools.at

EAN-Code
 90 02648

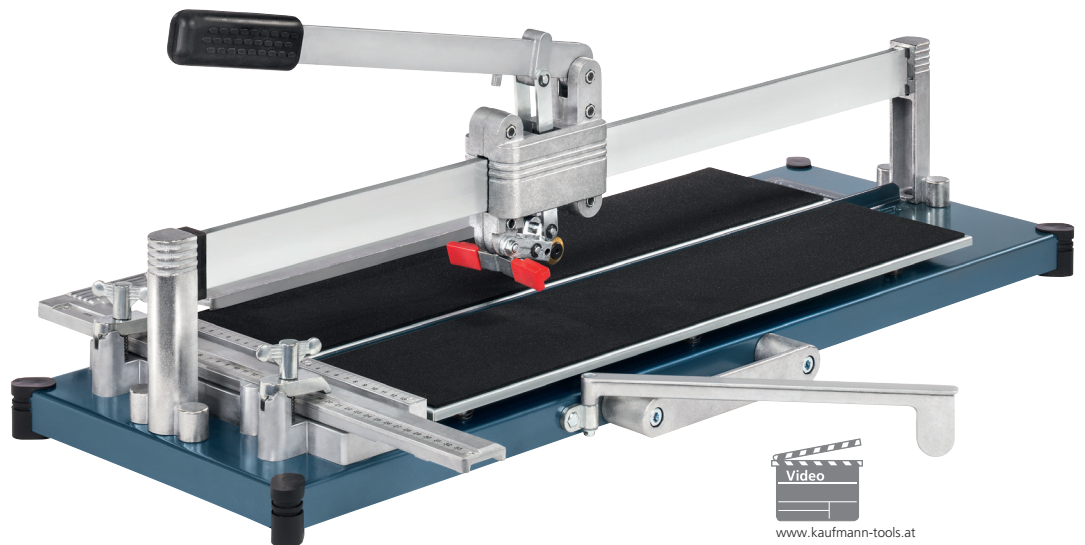

DE Fliesenschnidmaschine TOPLINE TWIST für den Linkshänder





volle Sicht auf das Schneirad für den Linkshänder • verstellbarer Anschlagwinkel für 90° und 45° mit 340mm Skala und Trapezführung • technische Daten siehe TopLine Pro auf Seite 19

EN Tile cutting machine TOPLINE TWIST for the left-hander

optimal view of the cutting wheel for the left-hander • adjustable angle for 90° and 45° with 340mm scale and trapezium guidance • technical details see TopLine Pro on page 19

FR Machine coupe-carreaux TOPLINE TWIST conçue pour gaucher

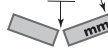
vision optimale sur la molette de coupe pour gaucher • équerre réglable pour 90° et 45° avec graduation de 340 mm et guidage trapézoïdale • caractéristiques techniques voir TopLine Pro page 19

Ref.						
10.850.02	630 mm	440x440 mm	18 mm	16 mm	15,6 kg	18694 9
10.850.03	720 mm	500x500 mm	18 mm	16 mm	13,0 kg	18695 6
10.850.04	920 mm	650x650 mm	18 mm	16 mm	16,0 kg	18969 3

mit Doppelwinkel, 2 Führungsschienen und Transporträder / with double angle, 2 guide rails and wheels for transport / avec double équerres, 2 rails de guidage et roulettes de transport

10.850.05	1250 mm	880x880 mm	18 mm	16 mm	23,4 kg	18697 0
-----------	---------	------------	-------	-------	---------	---------

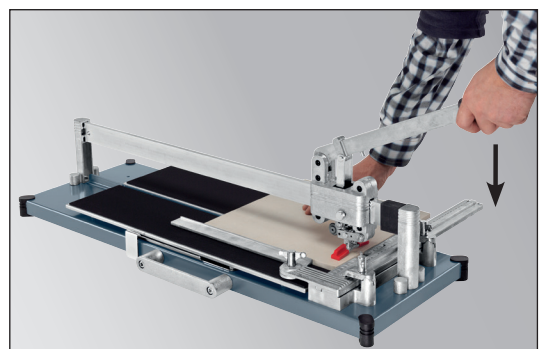
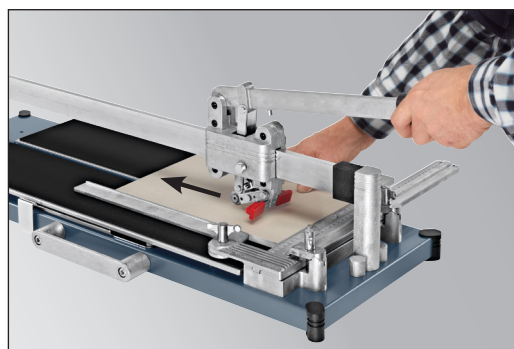



Kaufmann GmbH
 Tel. +43 5522 73 822
 Fax +43 5522 72 404
 www.kaufmann-tools.at
 office@kaufmann-tools.at

EAN-Code
 90 02648

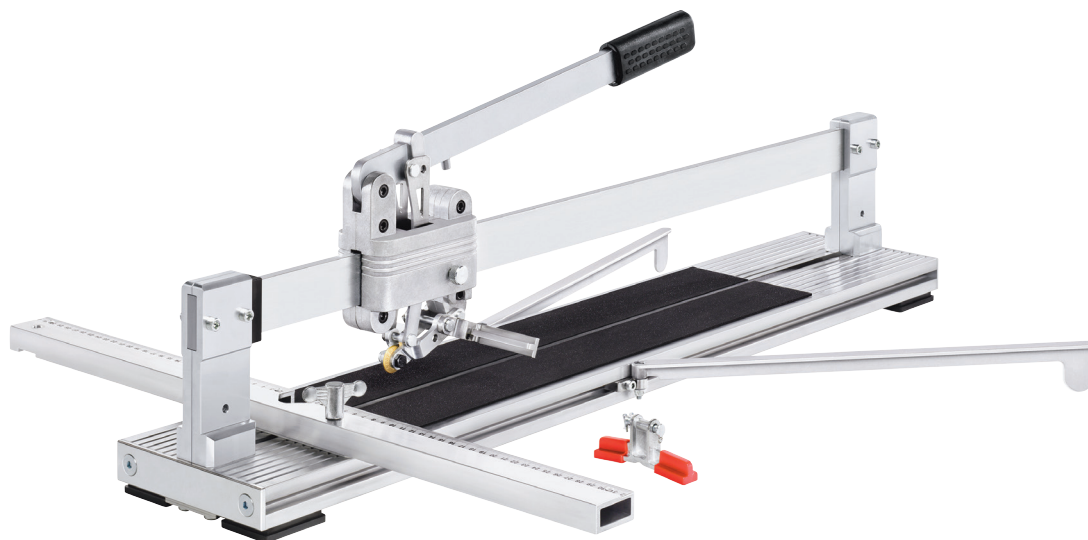

DE Fliesenschneidmaschine SUPERLINE für den professionellen Fliesenleger

für Klinker, Fliesen, Bodenplatten und Mosaik aus Steingut, Steinzeug, Feinsteinzeug und Glas • Schneidrichtung zur Anschlagleiste • optimale Sicht auf das Schneidgut • staubgeschützte und genaue Kugellagerführung (wartungsfrei) • extrabreite Anschlagleiste mit Millimeterskala • arretierbare Brechvorrichtung • Brechvorrichtung mit patentiertem Kraftübertragungssystem • ausgestattet mit 2 Brechern: breiter Brecher für Fliesen und Platten von 16 mm bis 20 mm Stärke sowie schmaler Brecher mit Schutzschuhen für Fliesen und Platten von 3,5 mm bis 18 mm Stärke, leicht umrüstbar • optionaler Brecher für Mosaik ab 15 x 15 mm (10.443.01) • robuste Alu/Stahlkonstruktion • Auflageflächen mit rutschfestem Zellkautschukbelag • rutschfeste Gummifüße verhindern Kratzer oder Spuren bei bestehender Verfliesung • professionelles Hartmetall-Schneidrad Ø22 mm mit TiN-Beschichtung • Seitenauflegeverbreiterung • Transportsicherung für Führungskopf

EN Tile cutting machine SUPERLINE for the professional tiler

for clinker, tiles, slabs and mosaics made of earthenware, stoneware, porcelain stoneware and glass • cutting direction towards the stop bar • optimal view of the tile • dust-protected and precise ball bearing cutting head (maintenance free) • extra wide stop bar with millimetre scale • lockable breaking device • breaking device with patented force transmission system • equipped with 2 breakers: wide breaker for tiles and slabs from 16 mm to 20 mm thickness as well as narrow breaker with safety pads for tiles and slabs from 3,5 mm to 18 mm thickness, easily converted • optional breaker for mosaic from 15 x 15 mm (10.443.01) • robust construction made of die-cast aluminium and steel • overlay with anti-skid cellular rubber covering • rubber feet ensure skid resistance and protect against scratches on finished tiles • professional tungsten carbide cutting wheel Ø22 mm with TiN-coating • side supporting surfaces • lockable cutting head for safe transport

FR Machine coupe-carreaux SUPERLINE pour le carreleur professionnel

pour les briques recuites, carrelages, dalles et mosaïques en faïence, grès, grès-cérame et verre • direction de coupe vers la barre de butée • vision optimale sur la molette pendant la coupe • tête coulissante équipée de roulements à bille précis et protégée contre la poussière (sans entretien) • barre de butée extra-large avec graduation en millimètre • dispositif de casse avec système de blocage • dispositif de casse avec système patenté de transmission de force • équipée avec 2 séparateurs: séparateur large pour carreaux et dalles de 16 mm à 20 mm d'épaisseur ainsi que séparateur fin avec revêtements de protection pour carreaux et dalles de 3,5 mm à 18 mm d'épaisseur, facile à modifier • en option: séparateur pour mosaïque de 15 x 15 mm (10.443.01) • construction robuste en aluminium et acier • surfaces d'appui avec semelles antidérapantes en caoutchouc cellulaire • pieds en caoutchouc antidérapants, évitant les traces sur le carrelage déjà posé • molette professionnelle au carbure de tungstène Ø22 mm avec enduction en TiN • appuis latéraux supplémentaires • dispositif de fixation de la tête de guidage pour le transport



in Kartonschachtel / in carton box / dans boîte en carton	Ref.	mm	mm	mm	mm	kg	kg	
10.860.02	630 mm	440 x 440 mm	20 mm	20 mm	11,1 kg	1,0 kg	19025 0	
10.860.04	920 mm	650 x 650 mm	20 mm	20 mm	13,5 kg	1,3 kg	19026 7	
10.860.05	1250 mm	880 x 880 mm	20 mm	20 mm	18,2 kg	3,2 kg	19031 1	



Anschlagleiste mit Millimeterskala / Stop bar with millimetre scale / Barre de butée avec graduation millimètre	Ref.	mm	
10.447.01	320 mm		19029 8
10.447.02	620 mm		19136 3



Kaufmann GmbH
 Tel. +43 5522 73 822
 Fax +43 5522 72 404
 www.kaufmann-tools.at
 office@kaufmann-tools.at

EAN-Code
 90 02648



DE Arbeitstisch für TopLine

für alle Modelle TopLine bis zu einer Schnittlänge von 1250 mm (mit Tischerweiterung bis zu Schnittlänge 1550 mm)
 • aus verzinktem Stahl • mit rutschfester Auflage • Tischfüsse klappbar, mit Schnellverschluss für raschen Auf- und Abbau • leicht und kompakt für den Transport • optionale Räder • optionale Tischerweiterung mit 2,5 cm starker Holzplatte • die Tischerweiterung kann auf allen 4 Seiten am Arbeitstisch positioniert werden

EN Worktable for TopLine

for all models TopLine up to a cutting length of 1250 mm (with supplement support up to cutting length 1550 mm)
 • made of galvanised steel • with anti-skid bearing surface • table-legs hinged, with quick fastener for a fast assembly and disassembly • lightweight and compact for transport • optional wheels • optional supplement support with wooden plate 2,5 cm thick • the supplement support can be positioned on all 4 sides at the working table

FR Table de travail pour TopLine

pour tous modèles TopLine jusqu'à une longueur de coupe de 1250 mm (avec support supplémentaire jusqu'à longueur de coupe de 1550 mm) • en acier galvanisé • avec surface d'appui antidérapante • pieds de table pliables, avec fermeture facile pour montage et démontage rapide • légère et compacte pour le transport • roulettes optionnelles • support supplémentaire optionnel avec plaque en bois de 2,5 cm d'épaisseur • le montage du support supplémentaire est possible sur les 4 côtés de la table

Ref.	mm	kg	Barcode
Arbeitstisch / Worktable / Table de travail			
10.500.01	1000x320x800 mm	9,6 kg	18740 3
Tischerweiterung / Supplement support / Support supplémentaire			
10.501.01	580x400x800 mm	4,9 kg	18741 0
Arbeitstisch mit 1 Stück Tischerweiterung / Worktable with 1 piece supplement support / Table de travail avec 1 pièce support supplémentaire			
10.502.01		14,5 kg	18795 3

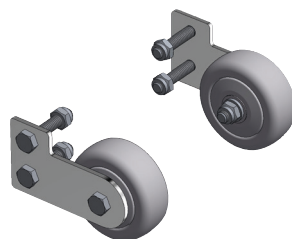

1 Paar Räder / 1 pair of wheels / 1 paire de roulettes

10.503.01		0,2 kg	18771 7
------------------	--	--------	---------



Kaufmann GmbH
 Tel. +43 5522 73 822
 Fax +43 5522 72 404
 www.kaufmann-tools.at
 office@kaufmann-tools.at

EAN-Code
 90 02648

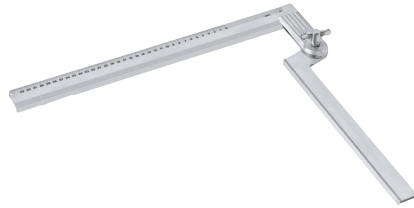

DE Anschlagwinkel für TopLine und CombiCut
 verstellbar für 90° und 45° • Trapezführung für eine exakte Fixierung

EN Angle for TopLine and CombiCut
 adjustable for 90° and 45° • trapezium guidance for an exact fixing

FR Equerre pour TopLine et CombiCut
 réglable pour 90° et 45° • guidage trapézoïdale pour une fixation exacte

Ref.	mm	
10.406.03 TopLine Standard, TopLine Rock	340 mm	17166 2
10.406.04 TopLine Pro	430 mm	18700 7
10.406.05 TopLine Twist	340 mm	18701 4
10.406.01 CombiCut	325 mm	16763 4

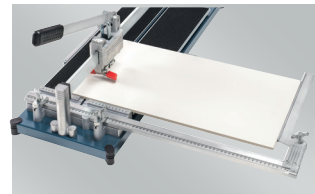

DE Langer Anschlagwinkel für TopLine
 verstellbar für 90° und 45° • Trapezführung für eine exakte Fixierung

EN Long angle for TopLine
 adjustable for 90° and 45° • trapezium guidance for an exact fixing

FR Equerre longue pour TopLine
 réglable pour 90° et 45° • guidage trapézoïdale pour une fixation exacte

Ref.	mm	
10.406.13 TopLine Standard, TopLine Rock	640 mm	18799 1
10.406.14 TopLine Pro	730 mm	18797 7

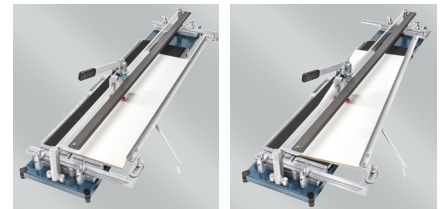

DE Winkelleiste für TopLine mit Doppelwinkel
 durchgehender seitlicher Anschlag für die exakte Einrichtung von großformatigen Fliesen

EN Angle bar for TopLine with double angle
 continuous lateral stop for the exact adjustment of large-sized tiles

FR Barre angulaire pour TopLine avec double équerres
 butée latérale en continue pour l'ajustement exact des carreaux de grand taille

Ref.	mm		
10.445.01	1250 mm	0–22°	18774 8
10.445.02	1550 mm	0–18°	18793 9
10.445.03	1830 mm	0–15°	18794 6



Kaufmann GmbH
Tel. +43 5522 73 822
Fax +43 5522 72 404
www.kaufmann-tools.at
office@kaufmann-tools.at

EAN-Code
90 02648



DE Schneiradhalter für Ø 14 mm für TopLine Rock und TopLine Pro

Set bestehend aus Stecker mit 2 Hartmetall-Schneirädern Ø 14 mm und 2 Achsen • speziell für Fliesen mit strukturierter Oberfläche

EN Cutting wheel holder for Ø 14 mm for TopLine Rock and TopLine Pro

set contents connector with 2 tungsten carbide cutting wheels Ø 14 mm and 2 spindles • particularly for tiles with structured surface

FR Porte-molette pour Ø 14 mm pour TopLine Rock et TopLine Pro

composition: connecteur avec 2 molettes au carbure de tungstène Ø 14 mm et 2 axes • conçu particulièrement pour carreaux avec surface structurée

Ref.



SB-verpackt, self-service packed, emballage self-service

10.438.02

18707 6



DE Mosaik-Brecher für TopLine

extra schmaler Brecher für Mosaik ab 1,5 x 1,5 cm

EN Breaker for mosaic for TopLine

extra-narrow breaker for mosaic from 1,5 x 1,5 cm

FR Séparateur pour mosaïque pour TopLine

séparateur très fin pour mosaïque à partir de 1,5 x 1,5 cm

Ref.



SB-verpackt, self-service packed, emballage self-service

10.443.01

18744 1



DE Lösehebel mit Sicherungsscheibe zu TopLine

für die Modelle Pro, Rock und Twist • für das Modell Standard ab Produktionsdatum 07/20 als Zubehör nachrüstbar

EN Release lever with lock washer for TopLine

for the models Pro, Rock and Twist • for the model Standard with production date from 07/20 retrofit as an accessory

FR Levier de déclenchement pour TopLine

pour le modèle Pro, Rock et Twist • rattraper comme accessoire pour le modèle Standard avec date de fabrication à partir de 07/20

Ref.



SB-verpackt, self-service packed, emballage self-service

10.449.01

19133 2



Kaufmann GmbH
 Tel. +43 5522 73 822
 Fax +43 5522 72 404
 www.kaufmann-tools.at
 office@kaufmann-tools.at

EAN-Code
 90 02648

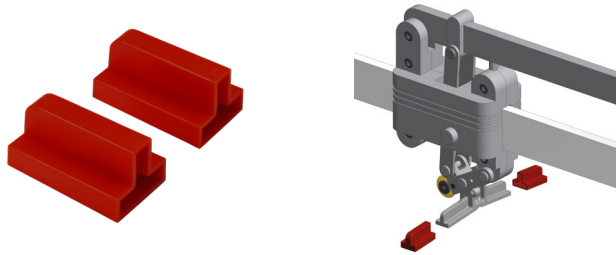

DE Schutzschuhe für TopLine

Aufsätze für Brecher • verhindern Schleif- oder Druckspuren auf glasierten Keramikfliesen • bei Fliesen aus Feinsteinzeug wird ohne die Schutzschuhe eine bessere Kraftübertragung erreicht

EN Safety pads for TopLine

attachments for breaker • protect against scratches or pressure marks on glazed ceramic tiles • on tiles made of porcelain stoneware a better power transmission is achieved without the safety pads

FR Revêtements de protection pour TopLine

accessoires pour dispositif de casse • évitant des traces de taille ou de pression sur carreaux céramiques vitrifiés • la transmission de puissance est meilleure pour carreaux en grès-cérame sans revêtements de protection



2 Stück SB-verpackt, 2 pieces self-service packed, 2 pièces emballées self-service
10.422.01

18121 0

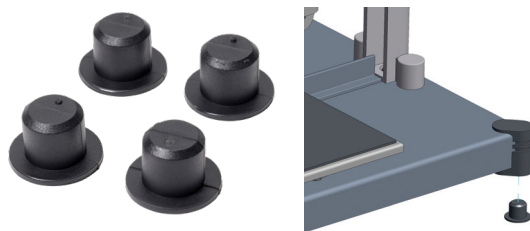

DE Rutschsicherung für TopLine

EN Anti-slip protection for TopLine

FR Bouchons antidérapants pour TopLine



4 Stück SB-verpackt, 4 pieces self-service packed, 4 pièces emballées self-service
10.444.01

18770 0



DE Achsen

EN Spindles

FR Axes



SB-verpackt, self-service packed, emballage self-service

10.970.51 Maxiflies, Superflies	01197 5
10.970.53 Uniflies	01195 1
10.970.55 TopLine Standard, SuperLine, CombiCut	16843 3
10.970.57 TopLine Rock, TopLine Pro, TopLine Twist	18768 7



Kaufmann GmbH
Tel. +43 5522 73 822
Fax +43 5522 72 404
www.kaufmann-tools.at
office@kaufmann-tools.at

EAN-Code
90 02648

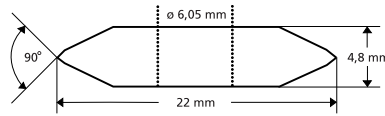

DE Hartmetall-Schneidrad Ø 22 mm PROFI

hohe Präzision durch breite, geschliffene Flanken • für TopLine, SuperLine, CombiCut, Profi 200, Maxiflies und Superflies

EN Tungsten carbide cutting wheel Ø 22 mm PROFI

high precision by wide, polished flanks • for TopLine, SuperLine, CombiCut, Profi 200, Maxiflies and Superflies

FR Molette au carbure de tungstène Ø 22 mm PROFI

haute précision par large flancs polis • pour TopLine, SuperLine, CombiCut, Profi 200, Maxiflies et Superflies



SB-verpackt, self-service packed, emballage self-service

10.980.21	Ø 22 mm	10	08150 3
------------------	---------	----	---------

lose, bulk, en vrac

10.980.22	Ø 22 mm	25	00308 6
------------------	---------	----	---------

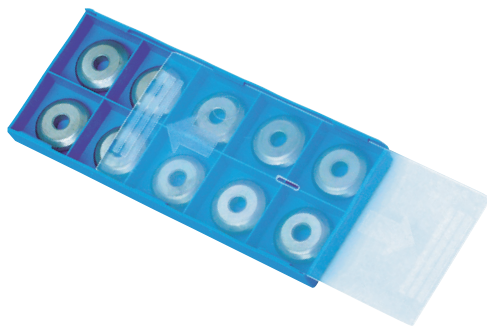

Kunststoffbox mit 10 Stück / plastic box with 10 pieces / boîte en plastique de 10 pièces

10.980.27	Ø 22 mm	1	17701 5
------------------	---------	---	---------

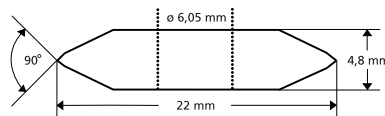

DE Hartmetall-Schneidrad Ø 22 mm TiN

mit Titanitrid-Beschichtung • hohe Präzision durch breite, geschliffene Flanken • für TopLine, SuperLine, CombiCut, Profi 200, Maxiflies, Superflies

EN Tungsten carbide cutting wheel Ø 22 mm TiN

with titanium-nitride-coating • high precision by wide, polished flanks • for TopLine, SuperLine, CombiCut, Profi 200, Maxiflies, Superflies

FR Molette au carbure de tungstène Ø 22 mm TiN

avec enduction en nitrure de titane • haute précision par large flancs polis • pour TopLine, SuperLine, CombiCut, Profi 200, Maxiflies, Superflies



SB-verpackt, self-service packed, emballage self-service

10.980.25	Ø 22 mm	10	18737 3
------------------	---------	----	---------

Kunststoffbox mit 10 Stück / plastic box with 10 pieces / boîte en plastique de 10 pièces

10.980.29	Ø 22 mm	1	18738 0
------------------	---------	---	---------



Kaufmann GmbH
 Tel. +43 5522 73 822
 Fax +43 5522 72 404
 www.kaufmann-tools.at
 office@kaufmann-tools.at

EAN-Code
 90 02648

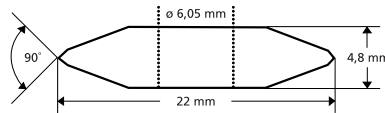

DE Hartmetall-Schneidrad Ø 22 mm
 für Maxiflies und Superflies

EN Tungsten carbide cutting wheel Ø 22 mm
 for Maxiflies and Superflies

FR Molette au carbure de tungstène Ø 22 mm
 pour Maxiflies et Superflies



SB-verpackt, self-service packed, emballage self-service

10.980.13	Ø 22 mm	10	00202 7
------------------	---------	----	---------

lose, bulk, en vrac

10.980.14	Ø 22 mm	25	00306 2
------------------	---------	----	---------

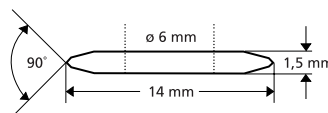
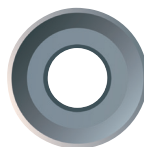

DE Hartmetall-Schneidrad Ø 14 mm
 für Euroflies, Austroflies, Uniflies, Fliesenschneid- und Brechzange sowie 10.438.02

EN Tungsten carbide cutting wheel Ø 14 mm
 for Euroflies, Austroflies, Uniflies, tile cutting and breaking pliers and 10.438.02

FR Molette au carbure de tungstène Ø 14 mm
 pour Euroflies, Austroflies, Uniflies, pince coupe-carreaux et 10.438.02



SB-verpackt, self-service packed, emballage self-service

10.980.01	Ø 14 mm	10	00198 3
------------------	---------	----	---------

lose, bulk, en vrac

10.980.02	Ø 14 mm	80	00304 8
------------------	---------	----	---------



Kaufmann GmbH
Tel. +43 5522 73 822
Fax +43 5522 72 404
www.kaufmann-tools.at
office@kaufmann-tools.at

EAN-Code
90 02648



DE **Zubehörbox TopLine Standard**

Set 10-teilig

EN **Accessory box TopLine Standard**

Set of 10 pieces

FR **Box avec accessoires TopLine Standard**

Ensemble de 10 pièces

Ref.



10.448.01

1

19131 8



DE **Zubehörbox TopLine PRO, ROCK und TWIST**

Set 12-teilig

EN **Accessory box TopLine PRO, ROCK and TWIST**

Set of 12 pieces

FR **Box avec accessoires TopLine PRO, ROCK et TWIST**

Ensemble de 12 pièces

Ref.



10.448.02

1

19132 5



Kaufmann GmbH
Tel. +43 5522 73 822
Fax +43 5522 72 404
www.kaufmann-tools.at
office@kaufmann-tools.at

EAN-Code
90 02648

- DE** Steintrennsäge TITAN
- EN** Stone saw TITAN
- FR** Scie de chantier TITAN



www.kaufmann-tools.at



Kaufmann GmbH
 Tel. +43 5522 73 822
 Fax +43 5522 72 404
 www.kaufmann-tools.at
 office@kaufmann-tools.at

EAN-Code
 90 02648

DE Steintrennsäge TITAN

für Fliesen-, Marmor- und Granitverleger, Gartengestalter, Pflasterer, Ofensetzer • Schnittlängen bis zu 2500 mm lieferbar • Schnitthöhe von 0–155 mm stufenlos einstellbar • leicht umrüstbar auf 300 mm, 350 mm oder 400 mm Diamantblätter • solide Bauweise aus Aluminium und rostfreiem Stahl • mit zwei Traggriffen, leicht zu transportieren • präziser Schnitt von +/- 0,3 mm auf eine Schnittlänge von 600 mm • Gehrungsschnitt mit Skala, stufenlos einstellbar von 0° - 45° • mit Universal-Anschlagwinkel 300 mm, verstellbar von 0° - 180°, kann auf 3 Seiten montiert werden, CE-geprüft

Das Untergestell sowie der 300 mm Universal-Anschlagwinkel sind in der Grundversion enthalten. Weiteres Zubehör (wie Diamantblatt, Seitentisch etc.) finden Sie auf den Seiten 36 und 37.

EN Stone saw TITAN



for tile setters, marble and granite fabricators, garden figuration, paving stone contractors, stove fitters • cutting lengths available up to 2500 mm (8 ft.) • cutting height adjustable from 0–155 mm (0–6 in.) • easily converted to accept 300 mm (12 in.), 350 mm (14 in.) or 400 mm (16 in.) diamond blades • solid aluminium and stainless steel construction • easily transported with two carrying handles • tolerance of +/- 0,3 mm (1/64 of an inch) on a cutting length of 600 mm (2 ft.) • variable mitre cut from 0° - 45° with scale • with universal stop angle 300 mm (12 in.), adjustable from 0° - 180°, can be mounted on 3 sides of the saw, CE-approved

The stand and the 300 mm universal stop angle are included in the basic equipment. Other accessories (such as diamond blade, side table etc.) please find on the pages 36 and 37.



FR Scie de chantier TITAN

pour carreleurs, poseurs de marbre et granit, paysagistes, paveurs, fumistes • longueurs de coupes livrables jusqu'à 2500 mm • hauteur de coupe réglable de 0–155 mm • disques diamantés faciles à ajuster à 300 mm, 350 mm ou 400 mm • construction robuste en aluminium et acier inoxydable • avec deux poignées de transport, facile à transporter • coupe précise de +/- 0,3 mm sur une longueur de coupe de 600 mm • coupe à onglet avec règlette, réglable de 0° - 45° • avec équerre-butée universelle 300 mm, réglable de 0° - 180°, le montage est possible sur 3 côtés, CE-certifié

Le support ainsi que l'équerre-butée universelle 300 mm sont compris dans l'équipement de base. Vous trouverez d'autres accessoires (comme disque diamant, table latérale etc.) aux pages 36 et 37.

Ref.			
230 V / 2,2 kW / 50 Hz / 16 A			
93.330.09	850 mm	30 mm	89 kg
93.330.04	1300 mm	30 mm	94 kg
93.330.05	1500 mm	30 mm	101 kg
93.330.11	1830 mm	30 mm	121 kg
93.330.07	2500 mm	30 mm	205 kg

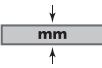
400 V / 3,0 kW / 50 Hz / 10 A			
93.340.09	850 mm	30 mm	89 kg
93.340.04	1300 mm	30 mm	94 kg
93.340.05	1500 mm	30 mm	101 kg
93.340.11	1830 mm	30 mm	121 kg
93.340.07	2500 mm	30 mm	205 kg

		
300 mm	0 - 105 mm	0 - 60 mm
350 mm	0 - 130 mm	0 - 80 mm
400 mm	0 - 155 mm	0 - 95 mm



Kaufmann GmbH
Tel. +43 5522 73 822
Fax +43 5522 72 404
www.kaufmann-tools.at
office@kaufmann-tools.at

EAN-Code
90 02648

DE Steintrennsäge CLASSIC

EN Stone saw CLASSIC

FR Scie de chantier CLASSIC

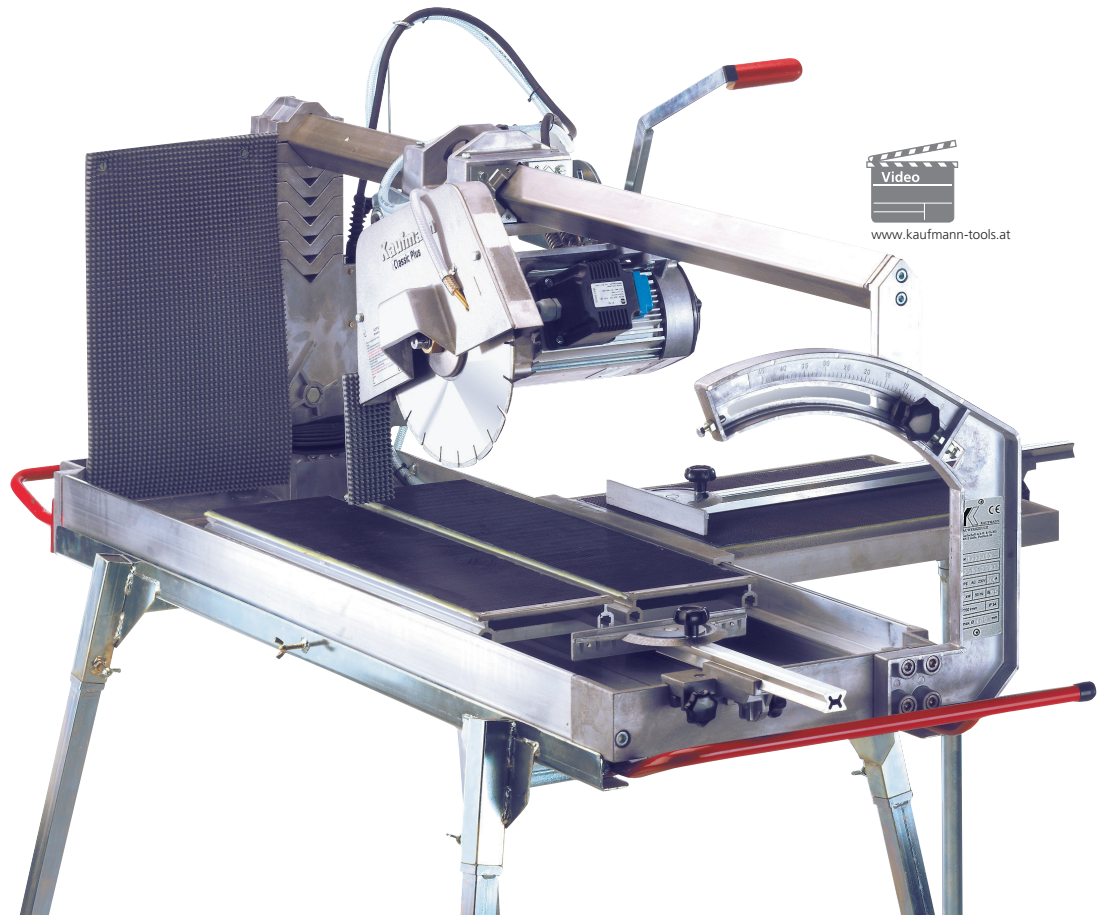



Kaufmann GmbH
 Tel. +43 5522 73 822
 Fax +43 5522 72 404
 www.kaufmann-tools.at
 office@kaufmann-tools.at

EAN-Code
 90 02648

DE Steintrennsäge CLASSIC

für Fliesen-, Marmor- und Granitverleger, Kunststeinverarbeiter, Gartengestalter, Pflasterer • Schnittlängen bis zu 1830 mm lieferbar • Schnitthöhe von 0–80 mm stufenlos einstellbar • leicht umrüstbar auf 250 mm oder 300 mm Diamantblätter • solide Bauweise aus Aluminium und rostfreiem Stahl • mit zwei Traggriffen, leicht zu transportieren • präziser Schnitt von +/- 0,3 mm auf eine Schnittlänge von 600 mm • Gehrungsschnitt mit Skala, stufenlos einstellbar von 0° - 45° • mit Universal-Anschlagwinkel 300 mm, verstellbar von 0° - 180°, kann auf 3 Seiten montiert werden, CE-geprüft

Das Untergestell sowie der 300 mm Universal-Anschlagwinkel sind in der Grundversion enthalten. Weiteres Zubehör (wie Diamantblatt, Seitentisch etc.) finden Sie auf den Seiten 36 und 37.

EN Stone saw CLASSIC

for tile setters, marble and granite fabricators, artificial stone processors, garden figuration, paving stone contractors • cutting lengths available up to 1830 mm (6 ft.) • cutting height adjustable from 0–80 mm (0–3 in.) • easily converted to accept 250 mm (10 in.) or 300 mm (12 in.) diamond blades • solid aluminium and stainless steel construction • easily transported with two carrying handles • tolerance of +/- 0,3 mm (1/64 of an inch) on a cutting length of 600 mm (2 ft.) • variable mitre cut from 0° - 45° with scale • with universal stop angle 300 mm (12 in.), adjustable from 0° - 180°, can be mounted on 3 sides of the saw, CE-approved



The stand and the 300 mm universal stop angle are included in the basic equipment. Other accessories (such as diamond blade, side table etc.) please find on the pages 36 and 37.

FR Scie de chantier CLASSIC

pour carreleurs, poseurs de marbre et granit, spécialistes du travail des agglomérés, paysagistes, paveurs • longueurs de coupes livrables jusqu'à 1830 mm • hauteur de coupe réglable de 0–80 mm • disques diamantés facile à ajuster à 250 mm ou 300 mm • construction robuste en aluminium et acier inoxydable • avec deux poignées de transport, facile à transporter • coupe précise de +/- 0,3 mm sur une longueur de coupe de 600 mm • coupe à onglet avec règle, réglable de 0° - 45° • avec équerre-butée universelle 300 mm, réglable de 0° - 180°, le montage est possible sur 3 côtés, CE-certifié

Le support ainsi que l'équerre-butée universelle 300 mm sont compris dans l'équipement de base. Vous trouverez d'autres accessoires (comme disque diamant, table latérale etc.) aux pages 36 et 37.

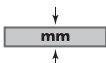
Ref.			
230 V / 2,2 kW / 50 Hz / 16 A			
93.220.04	850 mm	30 mm	82 kg
93.220.06	1300 mm	30 mm	91 kg
93.220.08	1500 mm	30 mm	97 kg
93.220.09	1830 mm	30 mm	112 kg
400 V / 3,0 kW / 50 Hz / 10 A			
93.240.04	850 mm	30 mm	82 kg
93.240.06	1300 mm	30 mm	91 kg
93.240.08	1500 mm	30 mm	97 kg
93.240.09	1830 mm	30 mm	112 kg

		
250 mm	0 - 50 mm	0 - 35 mm
300 mm	0 - 80 mm	0 - 60 mm



Kaufmann GmbH
Tel. +43 5522 73 822
Fax +43 5522 72 404
www.kaufmann-tools.at
office@kaufmann-tools.at

EAN-Code
90 02648

DE Diamanttrennscheibe für Steintrennsägen
für Nassschnitt • Innenbohrung Ø 30 mm

EN Diamond cutting disc for stone saws
for wet cutting • hole inside Ø 30 mm

FR Disques diamant pour scies de chantier
pour coupe à eau • alésage Ø 30 mm



300 mm



400 mm



DE Beton, Waschbeton

EN concrete, washed concrete

FR béton, béton lavé

93.980.02

DE Fliesen, mit geschlossenem Schneidrand

EN tiles, with closed cutting edge

FR carreaux, à segments jante continue

93.982.02

DE Feinsteinzeugplatten, mit Flanschverstärkung, mit geschlossenem Schneidrand

EN porcelain stoneware slabs, with flange reinforcement, with closed cutting edge

FR grès-cérame, avec flasque renforcé, à segments jante continue

93.992.02

DE Fliesen, Porzellan (Gress), dünnes Feinsteinzeug und dünne Granite, mit geschlossenem Schneidrand

EN tiles, porcelain (gres), thin porcelain stoneware and granite, with closed cutting edge

FR carreaux, porcelaine (grès), grès-cérame mince et granit mince, à segments jante continue

93.996.02

DE Terrakotta, Klinker

EN terracotta, clinker

FR terre cuite, briques recuites

93.998.02

DE Marmor, Fliesen, Kacheln

EN marble, tiles, Dutch tiles

FR marbre, carreaux, carreaux de faïences

93.984.02

DE Sandstein, Schamotte, Basalt, Lava

EN sandstone, fireclay, basalt, lava

FR grès, chamotte, basalte, lave

93.994.04

DE Universal

EN universal

FR universel

93.977.02

DE hartes Feinsteinzeug bis 2 cm, Marmor, dünne Granite und Porzellan, engverzahnt

EN hard porcelain stoneware up to 2 cm, marble, thin granite and porcelain, narrow joints

FR grès-cérame dur jusqu'à 2 cm du force, marbre, granite mince et porcelaine, denture étroite

93.993.02



Kaufmann GmbH
 Tel. +43 5522 73 822
 Fax +43 5522 72 404
 www.kaufmann-tools.at
 office@kaufmann-tools.at

EAN-Code
 90 02648.....

- DE Räder für Untergestell**
bis zu einer Schnittlänge von 1300 mm
- EN Wheels for stand**
up to a cutting length of 1300 mm
- FR Roulettes pour support**
jusqu'à une longueur de coupe de 1300 mm



Ref.	kg
93.962.03	2,5 kg

- DE Universal-Anschlagwinkel**
komplett mit Winkelhalter
- EN Universal stop angle**
complete with mounting
- FR Equerre-butée universelle**
complète avec support

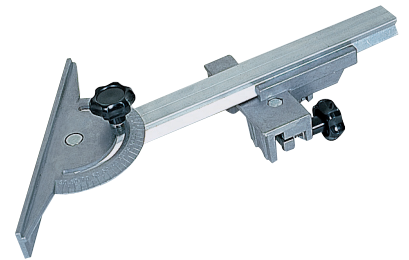

Ref.	mm	kg
93.965.01	300 mm	0,9 kg
93.965.02	600 mm	1,4 kg

- DE Seitentisch**
mit Leiste für Anschlagwinkel
- EN Side table**
with rail for cutting guide
- FR Table latérale**
avec rainure pour équerre-butée

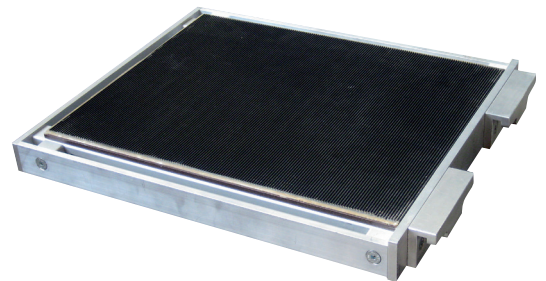

Ref.	mm	kg
93.963.01	400x500 mm	7,2 kg
93.963.02	800x500 mm	11,8 kg
93.963.03	1000x500 mm	14,2 kg

- DE Wasserpumpe**
- EN Water pump**
- FR Pompe à eau**



Ref.	⚡	W	Hz	kg
93.969.01	230V	50W	50Hz	1,3 kg



Kaufmann GmbH
 Tel. +43 5522 73 822
 Fax +43 5522 72 404
 www.kaufmann-tools.at
 office@kaufmann-tools.at

EAN-Code
 90 02648



DE **Maurerkelle rostfrei mit geradem Hals**
 2-Punkt-Schweissung mit 3 Jahren Garantie

EN **Mason's trowel stainless with straight neck**
 2-point-welded with 3 years warranty

FR **Truelle de maçon inox à col droit**
 soudure à 2 points avec 3 ans de garantie

Ref.	mm		Box	Barcode
	160mm	180mm		
 43.057.03	160 mm	180 mm	50	16647 7
43.057.01	160 mm	180 mm	50	00057 3



DE **Maurerkelle rostfrei mit geradem Hals, mit Softgriff**
 2-Punkt-Schweissung mit 3 Jahren Garantie

EN **Mason's trowel stainless with straight neck, with softgrip**
 2-point-welded with 3 years warranty

FR **Truelle de maçon inox à col droit, avec poignée bi-matière**
 soudure à 2 points avec 3 ans de garantie

Ref.	mm		Box	Barcode
	160mm	180mm		
 43.557.03	160 mm	180 mm	50	17387 1
43.557.01	160 mm	180 mm	45	17388 8

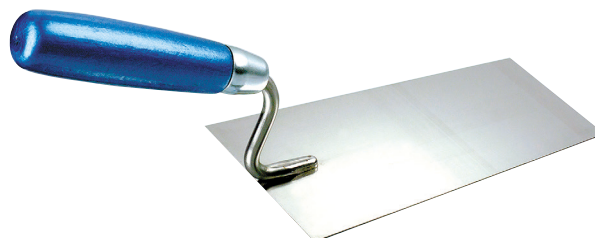

DE **Maurerkelle rostfrei mit Schwanenhals**
 2-Punkt-Schweissung mit 3 Jahren Garantie

EN **Mason's trowel stainless with swan's neck**
 2-point-welded with 3 years warranty

FR **Truelle de maçon inox à col de cygne**
 soudure à 2 points avec 3 ans de garantie

Ref.	mm		Box	Barcode
	160mm	180mm		
 43.059.03	160 mm	180 mm	50	17279 9
43.059.01	160 mm	180 mm	50	17280 5



Kaufmann GmbH
 Tel. +43 5522 73 822
 Fax +43 5522 72 404
 www.kaufmann-tools.at
 office@kaufmann-tools.at

EAN-Code
 90 02648



DE **Mauerkelle rostfrei mit Schwanenhals, mit Softgriff**
 2-Punkt-Schweissung mit 3 Jahren Garantie

EN **Mason's trowel stainless with swan's neck, with softgrip**
 2-point-welded with 3 years warranty

FR **Truelle de maçon inox à col de cygne, avec poignée bi-matière**
 soudure à 2 points avec 3 ans de garantie

	Ref.	mm		
	43.559.03	160 mm	50	17389 5
	43.559.01	180 mm	50	17390 1



DE **Mauerkelle rostfrei mit abgerundeten Kanten, mit Softgriff**
 2-Punkt-Schweissung mit 3 Jahren Garantie

EN **Mason's trowel stainless with rounded angles, with softgrip**
 2-point-welded with 3 years warranty

FR **Truelle de maçon inox avec bouts arrondis, avec poignée bi-matière**
 soudure à 2 points avec 3 ans de garantie

	Ref.	mm		
	43.556.01	180 mm	50	17968 2



DE **Degginger Mauerkelle rostfrei**
 2-Punkt-Schweissung mit 3 Jahren Garantie

EN **Mason's trowel Deggingen shape stainless**
 2-point-welded with 3 years warranty

FR **Truelle de maçon modèle Deggingen inox**
 soudure à 2 points avec 3 ans de garantie

	Ref.	mm		
	43.068.02	180 x 120 mm	50	17857 9



Kaufmann GmbH
 Tel. +43 5522 73 822
 Fax +43 5522 72 404
 www.kaufmann-tools.at
 office@kaufmann-tools.at

EAN-Code
 90 02648

DE Italienische Mauerkelle rostfrei
 2-Punkt-Schweissung mit 3 Jahren Garantie

EN Italian mason's trowel stainless
 2-point-welded with 3 years warranty

FR Truelle de maçon italienne inox
 soudure à 2 points avec 3 ans de garantie



mit Holzgriff, with wooden handle, avec poignée en bois



42.087.02
42.087.03

180 mm
 200 mm

50
 50

17437 3
 17438 0



DE Klinker- und Mauerkelle rostfrei
 2-Punkt-Schweissung mit 3 Jahren Garantie

EN Klinker- and mason's trowel stainless
 2-point-welded with 3 years warranty

FR Truelle à briqueter et de maçon inox
 soudure à 2 points avec 3 ans de garantie



mit Holzgriff, with wooden handle, avec poignée en bois



42.117.01

190 mm

50

17941 5

mit Softgriff, with softgrip, avec poignée bi-matière

42.118.01

190 mm

50

17943 9

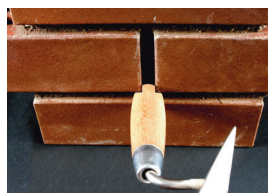

DE Klinker- und Mauerkelle rostfrei, mit Fugenlehre
 2-Punkt-Schweissung mit 3 Jahren Garantie

EN Klinker- and mason's trowel stainless, with joint gauge
 2-point-welded with 3 years warranty

FR Truelle à briqueter et de maçon inox, avec mesure pour joint
 soudure à 2 points avec 3 ans de garantie



42.119.01

190 mm

50

17942 2



Kaufmann GmbH
 Tel. +43 5522 73 822
 Fax +43 5522 72 404
 www.kaufmann-tools.at
 office@kaufmann-tools.at

EAN-Code
 90 02648

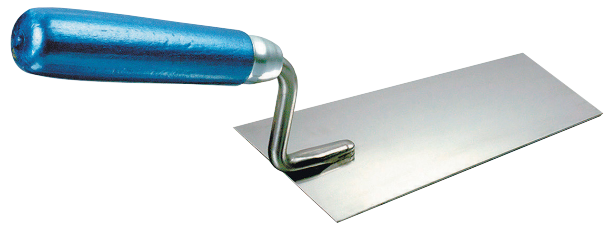

DE Berner Putzkelle rostfrei
 2-Punkt-Schweissung mit 3 Jahren Garantie

EN Plaster trowel Bern shape stainless
 2-point-welded with 3 years warranty

FR Truelle Bernoise inox
 soudure à 2 points avec 3 ans de garantie

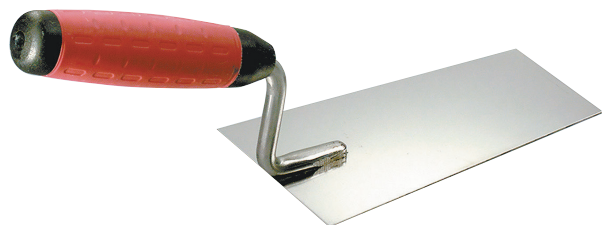

 Ref.			
	mm		
42.058.03	120 mm	50	17278 2
42.058.01	140 mm	50	00058 0
42.058.02	160 mm	50	00059 7



DE Berner Putzkelle rostfrei, mit Softgriff
 2-Punkt-Schweissung mit 3 Jahren Garantie

EN Plaster trowel Bern shape stainless, with softgrip
 2-point-welded with 3 years warranty

FR Truelle Bernoise inox, avec poignée bi-matière
 soudure à 2 points avec 3 ans de garantie

 Ref.			
	mm		
42.558.03	120 mm	50	17391 8
42.558.01	140 mm	50	17392 5
42.558.02	160 mm	50	17393 2



Kaufmann GmbH
 Tel. +43 5522 73 822
 Fax +43 5522 72 404
 www.kaufmann-tools.at
 office@kaufmann-tools.at

EAN-Code
 90 02648



- DE Giperspachtel rostfrei**
2-Punkt-Schweissung mit 3 Jahren Garantie
- EN Spatula trowel stainless**
2-point-welded with 3 years warranty
- FR Truelle de plâtrier inox**
soudure à 2 points avec 3 ans de garantie

Ref.	mm		
42.060.10	30 mm	50	00939 2
42.060.01	40 mm	50	00504 2
42.060.02	50 mm	50	00060 3
42.060.03	60 mm	50	00061 0
42.060.04	70 mm	50	00175 4
42.060.05	80 mm	50	00062 7
42.060.06	100 mm	50	00505 9
42.060.07	120 mm	50	17277 5



- DE Giperspachtel rostfrei, mit Softgriff**
2-Punkt-Schweissung mit 3 Jahren Garantie
- EN Spatula trowel stainless, with softgrip**
2-point-welded with 3 years warranty
- FR Truelle de plâtrier inox, avec poignée bi-matière**
soudure à 2 points avec 3 ans de garantie

Ref.	mm		
42.560.10	30 mm	50	17394 9
42.560.01	40 mm	50	17395 6
42.560.02	50 mm	50	17396 3
42.560.03	60 mm	50	17397 0
42.560.04	70 mm	50	17398 7
42.560.05	80 mm	50	17399 4
42.560.06	100 mm	50	17400 7
42.560.07	120 mm	50	17401 4
42.560.08	140 mm	50	18198 2



- DE Giperspachtel rostfrei, gezahnt**
2-Punkt-Schweissung mit 3 Jahren Garantie
- EN Spatula trowel stainless, notched**
2-point-welded with 3 years warranty
- FR Truelle de plâtrier inox, dentée**
soudure à 2 points avec 3 ans de garantie

Ref.		mm		
42.068.06	E6	60 mm	50	17173 0

Zahnungen siehe auf Seiten 86–87 / Notches see on pages 86–87 / Dentures voir pages 86–87



Kaufmann GmbH
 Tel. +43 5522 73 822
 Fax +43 5522 72 404
 www.kaufmann-tools.at
 office@kaufmann-tools.at

EAN-Code
 90 02648



DE Katzenzungenkelle rostfrei
 2-Punkt-Schweissung mit 3 Jahren Garantie

EN Cat's tongue trowel stainless
 2-point-welded with 3 years warranty

FR Truelle langue de chat inox
 soudure à 2 points avec 3 ans de garantie

Ref.	mm		
 42.063.02	140 mm	50	17281 2
42.063.01	160 mm	50	00063 4



DE Katzenzungenkelle rostfrei, mit Softgriff
 2-Punkt-Schweissung mit 3 Jahren Garantie

EN Cat's tongue trowel stainless, with softgrip
 2-point-welded with 3 years warranty

FR Truelle langue de chat inox, avec poignée bi-matière
 soudure à 2 points avec 3 ans de garantie

Ref.	mm		
 42.563.02	140 mm	50	17411 3
42.563.01	160 mm	50	17412 0



DE Hamburger Spitzkelle rostfrei
 2-Punkt-Schweissung mit 3 Jahren Garantie

EN Pointed trowel Hamburg shape stainless
 2-point-welded with 3 years warranty

FR Truelle pointue modèle Hambourg inox
 soudure à 2 points avec 3 ans de garantie

Ref.	mm		
 42.084.01	140 mm	50	17282 9



Kaufmann GmbH
 Tel. +43 5522 73 822
 Fax +43 5522 72 404
 www.kaufmann-tools.at
 office@kaufmann-tools.at

EAN-Code
 90 02648

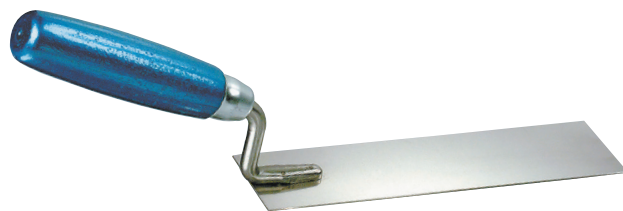

DE Berliner Stecherkelle rostfrei
 2-Punkt-Schweissung mit 3 Jahren Garantie

EN Joint scraper Berlin shape stainless
 2-point-welded with 3 years warranty

FR Truelle à piquer modèle Berlin inox
 soudure à 2 points avec 3 ans de garantie

Ref.	mm		
42.085.01	180x25 mm	50	17305 5
42.085.02	180x30 mm	50	17283 6
42.085.04	180x40 mm	50	17284 3
42.085.06	180x50 mm	50	17285 0



DE Giperspachtel rostfrei, mit langem Holzgriff
 2-Punkt-Schweissung mit 3 Jahren Garantie

EN Spatula trowel stainless, with long wooden handle
 2-point-welded with 3 years warranty

FR Truelle de plâtrier inox, avec longue poignée en bois
 soudure à 2 points avec 3 ans de garantie

Ref.	mm		
42.061.05	80 mm	40	16810 5
42.061.06	100 mm	40	18558 4

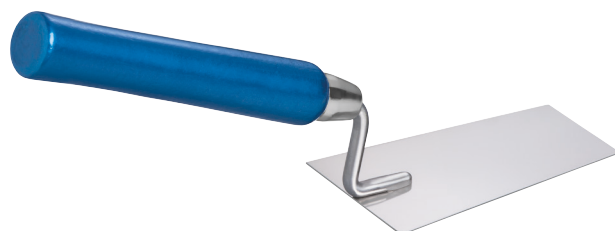

DE Fliesenkelte Süddeutsche Form rostfrei
 2-Punkt-Schweissung mit 3 Jahren Garantie

EN Tiler's trowel stainless
 2-point-welded with 3 years warranty

FR Truelle de carreleur inox
 soudure à 2 points avec 3 ans de garantie

Ref.	mm		
42.058.50	140 mm	40	18567 6



Kaufmann GmbH
Tel. +43 5522 73 822
Fax +43 5522 72 404
www.kaufmann-tools.at
office@kaufmann-tools.at

EAN-Code
90 02648



DE Inneneckenkelle rostfrei
2-Punkt-Schweissung mit 3 Jahren Garantie

EN Corner trowel inside stainless
2-point-welded with 3 years warranty

FR Truelle d'angle intérieur inox
soudure à 2 points avec 3 ans de garantie

	Ref.	mm		
	42.064.01	120x97x97 mm	30	00064 1
	42.064.02	110x75x75 mm	40	16697 2
	42.064.03	80x60x60 mm	50	16698 9

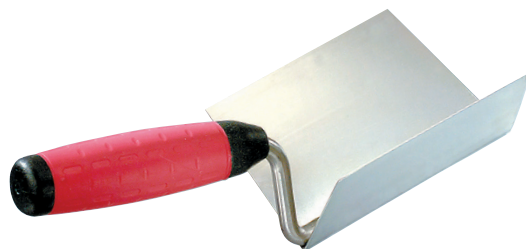

DE Inneneckenkelle rostfrei, mit Softgriff
2-Punkt-Schweissung mit 3 Jahren Garantie

EN Corner trowel inside stainless, with softgrip
2-point-welded with 3 years warranty

FR Truelle d'angle intérieur inox, avec poignée bi-matière
soudure à 2 points avec 3 ans de garantie

	Ref.	mm		
	42.564.01	120x97x97 mm	30	17415 1
	42.564.02	110x75x75 mm	40	17416 8

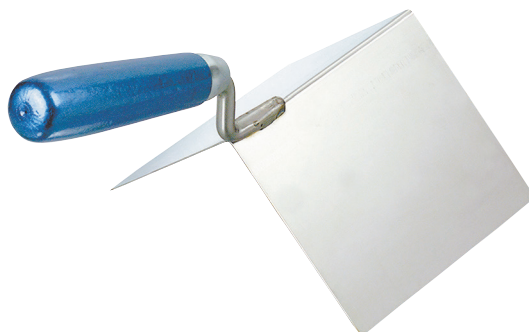

DE Ausseneckenkelle rostfrei
2-Punkt-Schweissung mit 3 Jahren Garantie

EN Corner trowel outside stainless
2-point-welded with 3 years warranty

FR Truelle d'angle extérieur inox
soudure à 2 points avec 3 ans de garantie

	Ref.	mm		
	42.065.01	120x97x97 mm	30	00065 8
	42.065.02	110x75x75 mm	40	16699 6
	42.065.03	80x60x60 mm	50	16700 9



Kaufmann GmbH
Tel. +43 5522 73 822
Fax +43 5522 72 404
www.kaufmann-tools.at
office@kaufmann-tools.at

EAN-Code
90 02648

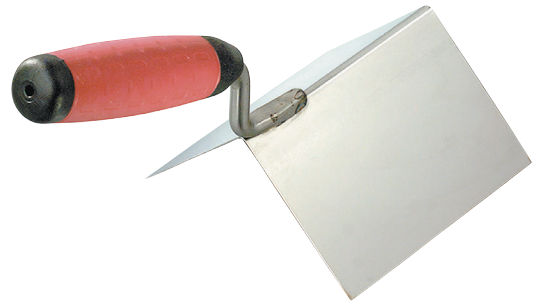

- DE Ausseneckenkelle rostfrei, mit Softgriff**
2-Punkt-Schweissung mit 3 Jahren Garantie
- EN Corner trowel outside stainless, with softgrip**
2-point-welded with 3 years warranty
- FR Truelle d'angle extérieur inox, avec poignée bi-matière**
soudure à 2 points avec 3 ans de garantie

Ref.	mm		
42.565.01	120x97x97 mm	30	17422 9
42.565.02	110x75x75 mm	40	17423 6

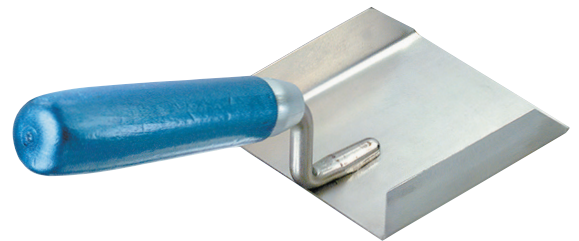

- DE Stuckateur-Eckenspachtel rostfrei**
2-Punkt-Schweissung mit 3 Jahren Garantie
- EN Plasterer corner trowel stainless**
2-point-welded with 3 years warranty
- FR Truelle d'angle de stucateur inox**
soudure à 2 points avec 3 ans de garantie

Ref.	mm		
42.304.01	80x90x20 mm	50	16701 6



- DE Vauerkelle / Herzgriffspachtel**
Steg 3-fach genietet • Blatt gefast
- EN Drywall scraper**
mounting triple-riveted • blade chamfered
- FR Racloir placoplâtre**
monture triple-rivetée • lame biseautée

Ref.	mm		
42.113.01	60x0,7 mm	50	17932 3
42.113.02	80x0,7 mm	50	17933 0
42.113.03	100x0,7 mm	50	17934 7
42.113.04	120x0,7 mm	50	17935 4
42.113.05	150x0,7 mm	50	17936 1

rostfrei, stainless, inox			
42.114.01	60x0,8 mm	50	17937 8
42.114.02	80x0,8 mm	50	17938 5
42.114.03	100x0,8 mm	50	17939 2
42.114.04	120x0,8 mm	50	17953 8
42.114.05	150x0,8 mm	50	17940 8



Kaufmann GmbH
 Tel. +43 5522 73 822
 Fax +43 5522 72 404
 www.kaufmann-tools.at
 office@kaufmann-tools.at



EAN-Code
 90 02648



DE Glättkelle PLATON gezahnt

EN Smoothing trowel PLATON notched

FR Platoir PLATON denté

Ref.	mm			
17.054.04	280x120x0,7 mm	E 4	33	18260 6
17.054.06	280x120x0,7 mm	E 6	33	18261 3
17.054.08	280x120x0,7 mm	E 8	33	18262 0
17.054.10	280x120x0,7 mm	E 10	33	18263 7
17.054.12	280x120x0,7 mm	E 12	33	18264 4

rostfrei, stainless, inox



17.055.04	280x120x0,7 mm	E 4	33	18265 1
17.055.06	280x120x0,7 mm	E 6	33	18266 8
17.055.08	280x120x0,7 mm	E 8	33	18267 5
17.055.10	280x120x0,7 mm	E 10	33	18268 2
17.055.12	280x120x0,7 mm	E 12	33	18269 9

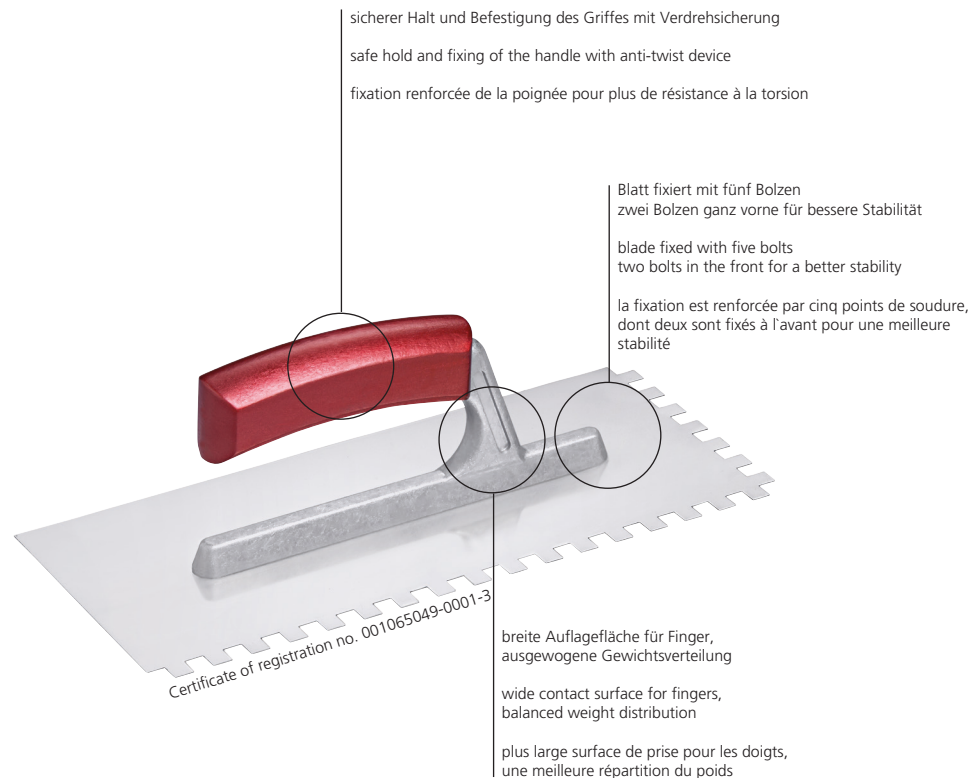

Zahnungen siehe auf Seiten 86–87 / Notches see on pages 86–87 / Dentures voir pages 86–87



Kaufmann GmbH
 Tel. +43 5522 73 822
 Fax +43 5522 72 404
 www.kaufmann-tools.at
 office@kaufmann-tools.at



EAN-Code
 90 02648



DE Glättkelle gezahnt mit Softgriff

EN Smoothing trowel notched with softgrip

FR Platoir denté avec poignée bi-matière

Ref.	mm			
17.036.04	280x130x0,7 mm	E4	10	17237 9
17.036.06	280x130x0,7 mm	E6	10	17193 8
17.036.08	280x130x0,7 mm	E8	10	17194 5
17.036.10	280x130x0,7 mm	E10	10	17195 2
17.032.04	280x130x0,7 mm	E4	33	17237 9
17.032.06	280x130x0,7 mm	E6	33	17193 8
17.032.08	280x130x0,7 mm	E8	33	17194 5
17.032.10	280x130x0,7 mm	E10	33	17195 2

rostfrei, stainless, inox



17.037.04	280x130x0,7 mm	E4	10	17224 9
17.037.06	280x130x0,7 mm	E6	10	17196 9
17.037.08	280x130x0,7 mm	E8	10	17197 6
17.037.10	280x130x0,7 mm	E10	10	17198 3
17.037.12	280x130x0,7 mm	E12	10	18533 1
17.037.15	280x130x0,7 mm	E15	10	18375 7
17.037.20	280x130x0,7 mm	E20	10	18644 4
17.037.52	280x130x0,7 mm	R15	10	17233 1
17.033.04	280x130x0,7 mm	E4	33	17224 9
17.033.06	280x130x0,7 mm	E6	33	17196 9
17.033.08	280x130x0,7 mm	E8	33	17197 6
17.033.10	280x130x0,7 mm	E10	33	17198 3

Zahnungen siehe auf Seiten 86–87 / Notches see on pages 86–87 / Dentures voir pages 86–87





Kaufmann GmbH
 Tel. +43 5522 73 822
 Fax +43 5522 72 404
 www.kaufmann-tools.at
 office@kaufmann-tools.at

EAN-Code
 90 02648



- DE** Glättkelle gezahnt
- EN** Smoothing trowel notched
- FR** Platoir denté

Ref.	mm			
17.014.04	280x130x0,7mm	E4	4	00433 5
17.014.06	280x130x0,7mm	E6	4	00014 6
17.014.08	280x130x0,7mm	E8	4	00475 5
17.014.10	280x130x0,7mm	E10	4	00438 0
17.014.12	280x130x0,7mm	E12	4	18142 5
17.016.03	280x130x0,7mm	E3	33	00432 8
17.016.04	280x130x0,7mm	E4	33	00433 5
17.016.06	280x130x0,7mm	E6	33	00014 6
17.016.08	280x130x0,7mm	E8	33	00475 5
17.016.10	280x130x0,7mm	E10	33	00438 0
17.016.12	280x130x0,7mm	E12	33	17993 4
17.016.15	280x130x0,7mm	E15	33	18350 4
17.016.51	280x130x0,7mm	R10	33	00476 2
17.016.52	280x130x0,7mm	R15	33	01407 5
17.016.53	280x130x0,7mm	R20	33	01408 2
17.016.61	280x130x0,7mm	R16	33	17589 9
17.016.37	280x130x0,7mm	T3	33	00437 3
17.016.39	280x130x0,7mm	T6	33	00515 8

rostfrei, stainless, inox



17.017.03	280x130x0,7mm	E3	4	01130 2
17.017.04	280x130x0,7mm	E4	4	01131 9
17.017.06	280x130x0,7mm	E6	4	01132 6
17.017.08	280x130x0,7mm	E8	4	01140 1
17.017.10	280x130x0,7mm	E10	4	01139 5
17.017.11	280x130x0,7mm	E11	4	01142 5
17.017.12	280x130x0,7mm	E12	4	18091 6
17.017.15	280x130x0,7mm	E15	4	18723 6
17.017.16	280x130x0,7mm	E16	4	01133 3
17.017.20	280x130x0,7mm	E20	4	18796 0
17.017.51	280x130x0,7mm	R10	4	01141 8
17.017.54	280x130x0,7mm	R12	4	17308 6
17.017.52	280x130x0,7mm	R15	4	00596 7
17.017.53	280x130x0,7mm	R20	4	00609 4
17.017.61	280x130x0,7mm	R16	4	17596 7
17.018.03	280x130x0,7mm	E3	33	01130 2
17.018.04	280x130x0,7mm	E4	33	01131 9
17.018.06	280x130x0,7mm	E6	33	01132 6
17.018.08	280x130x0,7mm	E8	33	01140 1
17.018.10	280x130x0,7mm	E10	33	01139 5
17.018.12	280x130x0,7mm	E12	33	18091 6

Zahnungen siehe auf Seiten 86–87 / Notches see on pages 86–87 / Dentures voir pages 86–87



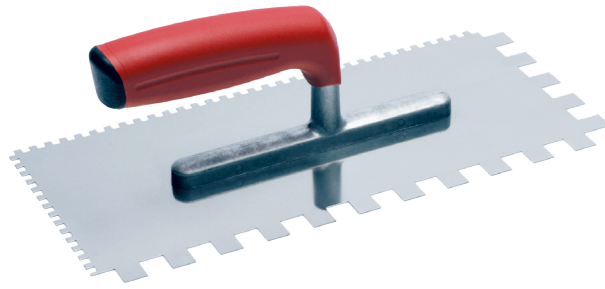

Kaufmann GmbH
 Tel. +43 5522 73 822
 Fax +43 5522 72 404
 www.kaufmann-tools.at
 office@kaufmann-tools.at

EAN-Code
 9002648.....



- DE** Glättkelle Doppelzahnung mit Softgriff
- EN** Smoothing trowel double notch with softgrip
- FR** Platoir double denture avec poignée bi-matière

Ref.	mm			
rostfrei, stainless, inox				
17.080.10	280x130x0,7 mm	E4 + E10	33	19150 9
17.080.12	280x130x0,7 mm	E4 + E12	33	19151 6



Zahnungen siehe auf Seiten 86–87 / Notches see on pages 86–87 / Dentures voir pages 86–87



Kaufmann GmbH
Tel. +43 5522 73 822
Fax +43 5522 72 404
www.kaufmann-tools.at
office@kaufmann-tools.at

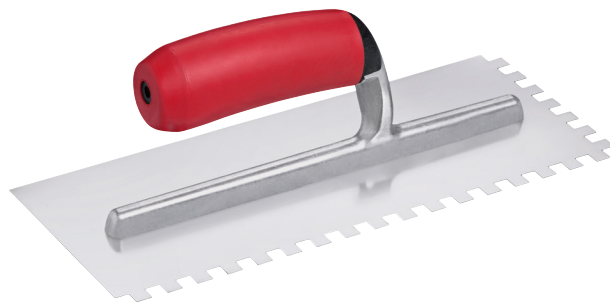

EAN-Code
90 02648



DE Amerikanische Glättetelle gezahnt mit Softgriff

EN American smoothing trowel notched with softgrip

FR Platoir américain inox denté avec poignée bi-matière

Ref.	mm			
rostfrei, stainless, inox				
17.980.04	280x120x0,7 mm	E4	33	17988 0
17.980.06	280x120x0,7 mm	E6	33	17989 7
17.980.08	280x120x0,7 mm	E8	33	17990 3
17.980.10	280x120x0,7 mm	E10	33	17991 0
17.980.12	280x120x0,7 mm	E12	33	18249 1



DE Handgriff mit Schrauben

für Zahnblätter mit verschiedenen Zahnungen

EN Handle with screws

for notched blades with different types of notches

FR Poignée avec jeu de vis

permet de changer de lame dentée

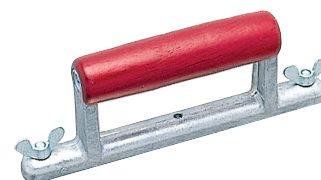

Ref.	mm	
17.260.01	200 mm	00030 6

DE Zahnblatt

für Floorbestglätte



EN Notched blade

for Floorbest trowel

FR Lame dentée

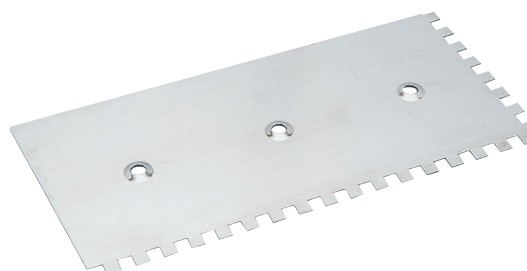
pour platoir multi-lames



Ref.	mm		
17.270.06	280x130x0,7 mm	E6	00031 3
17.270.08	280x130x0,7 mm	E8	00479 3
17.270.10	280x130x0,7 mm	E10	00453 3
17.270.11	280x130x0,7 mm	E11	00454 0
17.270.16	280x130x0,7 mm	E16	00448 9

Zahnungen siehe auf Seiten 86–87 / Notches see on pages 86–87 / Dentures voir pages 86–87



Kaufmann GmbH
 Tel. +43 5522 73 822
 Fax +43 5522 72 404
 www.kaufmann-tools.at
 office@kaufmann-tools.at

EAN-Code
 90 02648

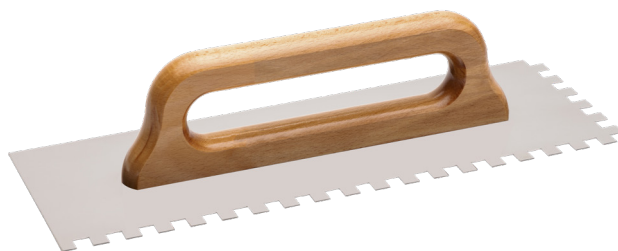

- DE Aufziehglätte KOMPAKT gezahnt**
Griff geschraubt
- EN Application trowel KOMPAKT notched**
handle screwed
- FR Taloche KOMPAKT dentée**
poignée fixée par vis

Ref.	mm			
rostfrei, stainless, inox				
17.300.06	380x130x0,7 mm	E 6	10	17999 6
17.300.08	380x130x0,7 mm	E 8	10	18000 8
17.300.10	380x130x0,7 mm	E 10	10	18001 5
17.300.11	380x130x0,7 mm	E 11	10	19126 4
17.300.12	380x130x0,7 mm	E 12	10	18673 4

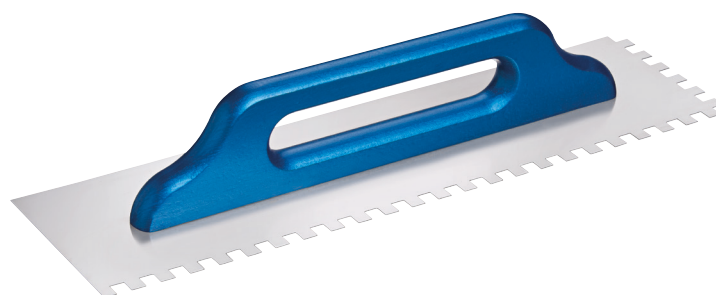

- DE Aufziehglätte EXPERT gezahnt**
Griff aufgedrückt
- EN Application trowel EXPERT notched**
handle pressed on
- FR Taloche EXPERT dentée**
poignée fixée par pression

Ref.	mm			
rostfrei, stainless, inox				
17.425.06	480x130x0,7 mm	E 6	25	16637 8
17.425.08	480x130x0,7 mm	E 8	25	16638 5
17.425.10	480x130x0,7 mm	E 10	25	16639 2
rostfrei, stainless, inox				
17.426.06	480x130x0,7 mm	E 6	25	16641 5
17.426.08	480x130x0,7 mm	E 8	25	16642 2
17.426.10	480x130x0,7 mm	E 10	25	16643 9



Zahnungen siehe auf Seiten 86–87 / Notches see on pages 86–87 / Dentures voir pages 86–87



Kaufmann GmbH
 Tel. +43 5522 73 822
 Fax +43 5522 72 404
 www.kaufmann-tools.at
 office@kaufmann-tools.at



EAN-Code
 90 02648



DE Aufziehglätte PROFI gezahnt
 Griff geschraubt

EN Application trowel PROFI notched
 handle screwed

FR Taloche PROFI dentée
 poignée fixée par vis

Ref.	mm			
17.424.03	500x130x0,7 mm	E 3	25	00424 3
17.424.04	500x130x0,7 mm	E 4	25	00425 0
17.424.06	500x130x0,7 mm	E 6	25	00426 7
17.424.08	500x130x0,7 mm	E 8	25	00477 9
17.424.10	500x130x0,7 mm	E 10	25	00431 1
17.424.11	500x130x0,7 mm	E 11	6	00546 2
17.424.12	500x130x0,7 mm	E 12	6	18013 8
17.424.15	500x130x0,7 mm	E 15	6	18351 1
17.424.18	500x130x0,7 mm	E 18	6	00428 1
17.424.26	500x130x0,7 mm	S 6	6	01116 6
17.424.51	500x130x0,7 mm	R 10	6	00478 6
17.424.52	500x130x0,7 mm	R 15	6	00551 6
17.424.53	500x130x0,7 mm	R 20	6	00552 3
17.424.61	500x130x0,7 mm	R 16	6	17599 8

rostfrei, stainless, inox



17.483.03	500x130x0,7 mm	E 3	6	01147 0
17.483.04	500x130x0,7 mm	E 4	6	01148 7
17.483.06	500x130x0,7 mm	E 6	25	01149 4
17.483.08	500x130x0,7 mm	E 8	25	01157 9
17.483.10	500x130x0,7 mm	E 10	25	01156 2
17.483.12	500x130x0,7 mm	E 12	6	18083 1
17.483.54	500x130x0,7 mm	R 12	25	17378 9
17.483.61	500x130x0,7 mm	R 16	6	17601 8

Zahnungen siehe auf Seiten 86–87 / Notches see on pages 86–87 / Dentures voir pages 86–87



Kaufmann GmbH
 Tel. +43 5522 73 822
 Fax +43 5522 72 404
 www.kaufmann-tools.at
 office@kaufmann-tools.at

EAN-Code
 90 02648



- DE** Glättkelle PLATON
- EN** Smoothing trowel PLATON
- FR** Platoir PLATON

Ref.	mm		
21.120.02	280x120x0,7 mm	33	18281 1



rostfrei, stainless, inox	280x120x0,7 mm	33	18284 2
---------------------------	----------------	----	---------



- DE** Glättkelle mit Softgriff
- EN** Smoothing trowel with softgrip
- FR** Platoir avec poignée bi-matière

Ref.	mm		
21.072.01	280x130x0,7 mm	10	17199 0
21.067.01	280x130x0,7 mm	33	17199 0



rostfrei, stainless, inox	280x130x0,7 mm	10	17200 3
21.069.01	280x130x0,7 mm	33	17200 3
21.068.01	280x130x0,7 mm	33	17217 1
21.068.04 gefast, chamfered, biseautée	280x130x0,7 mm	10	17666 7
21.011.13	280x130x1,0 mm		



Kaufmann GmbH
 Tel. +43 5522 73 822
 Fax +43 5522 72 404
 www.kaufmann-tools.at
 office@kaufmann-tools.at

EAN-Code
 90 02648



- DE** Glättkelle mit gebogenem Holzgriff
- EN** Smoothing trowel with curved wooden handle
- FR** Platoir avec poignée courbée en bois

Ref.	mm		
21.007.01	280x130x0,7 mm	4	00007 8
21.007.02	280x130x0,7 mm	33	00007 8
21.007.04 gefast, chamfered, biseautée	280x130x0,7 mm	33	01440 2

rostfrei, stainless, inox



21.010.01	280x130x0,7 mm	4	00010 8
21.010.05	280x130x0,7 mm	10	00010 8
21.010.02	280x130x0,7 mm	33	00010 8
21.011.01	280x130x1,0 mm	4	00011 5
21.011.02	280x130x1,0 mm	33	00011 5



- DE** Glättkelle mit zylindrischem Holzgriff
- EN** Smoothing trowel with cylindrical wooden handle
- FR** Platoir avec poignée cylindrique en bois

Ref.	mm		
21.001.06	280x130x0,7 mm	10	18227 9



- DE** Glättkelle mit balligem Holzgriff
- EN** Smoothing trowel with ball-shaped wooden handle
- FR** Platoir avec poignée bombée en bois

Ref.	mm		
21.004.01	280x130x0,7 mm	4	00004 7
21.004.02	280x130x0,7 mm	33	00004 7



Kaufmann GmbH
Tel. +43 5522 73 822
Fax +43 5522 72 404
www.kaufmann-tools.at
office@kaufmann-tools.at

EAN-Code
90 02648

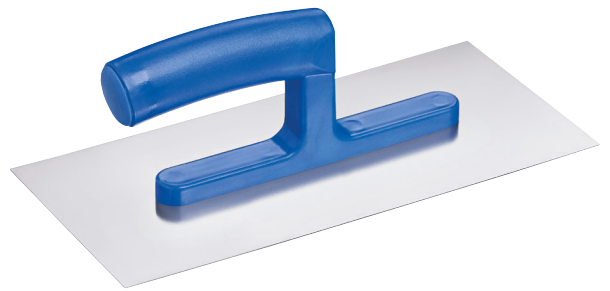

- DE Glättekelle ABS**
mit gebogenem Griff und Steg aus ABS
- EN Smoothing trowel ABS**
with curved handle and mounting made of ABS
- FR Platoir ABS**
avec poignée courbée et monture en ABS

Ref.	mm		
21.050.01	280x130x0,7mm	38	16604 0
rostfrei, stainless, inox			
21.051.01	280x130x0,7mm	38	16605 7





Kaufmann GmbH
 Tel. +43 5522 73 822
 Fax +43 5522 72 404
 www.kaufmann-tools.at
 office@kaufmann-tools.at

EAN-Code
 90 02648



- DE** Amerikanische Glättkelle
- EN** American smoothing trowel
- FR** Platoir américain

Ref.	mm		
21.012.01	280x120x0,7 mm	33	00053 5



rostfrei, stainless, inox



21.013.01	280x120x0,7 mm	33	00054 2
------------------	----------------	----	---------



- DE** Amerikanische Glättkelle mit Softgriff
- EN** American smoothing trowel with softgrip
- FR** Platoir américain avec poignée bi-matière

Ref.	mm		
21.078.01	280x120x0,7 mm	33	17992 7
21.078.04	300x120x0,7 mm	18	18211 8
21.078.05	400x120x0,7 mm	18	18212 5

rostfrei, stainless, inox



- DE** Querschliff-Glättkelle rostfrei
Blatt konkav
- EN** Smoothing trowel stainless with crosswise grinding
blade concave
- FR** Platoir inox avec tranchant transversal
lame concave

Ref.	mm		
21.079.02	400x120x0,7 mm	18	18214 9





Kaufmann GmbH
 Tel. +43 5522 73 822
 Fax +43 5522 72 404
 www.kaufmann-tools.at
 office@kaufmann-tools.at

EAN-Code
 9002648.....

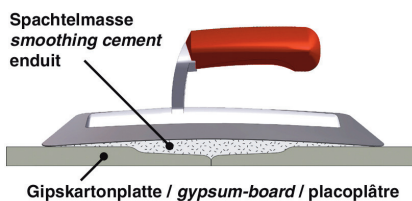

DE Trockenbaukelle rostfrei
 mit gebogenem Blatt und abgerundeten Ecken

EN Drywall trowel stainless
 with curved blade and rounded corners

FR Platoir inox pour joints de placoplâtre
 avec lame courbe et angles arrondis



mit Softgriff, with softgrip, avec poignée bi-matière



21.023.02

280x120x0,7 mm

33

17959 0

DE Pool-Glättekelle rostfrei
 beidseitig rund

EN Pool trowel stainless
 both sides round

FR Platoir inox avec bouts arrondis
 rond des deux côtés



21.073.01

300x80x0,7 mm

25

18343 6

DE Venezianische Glättekelle rostfrei, mit Softgriff
 für Glätt- und Effektpachtelung wie Stucco-Veneziana,
 Glanz- und Marmorputze

EN Venetian smoothing trowel stainless, with softgrip
 for smoothing decorative stucco and structuring such as
 Venetian plaster, gloss- and marble-plaster

FR Platoir vénitien inox, avec poignée bi-matière
 pour l'application de produits décoratifs comme stucco-vénitien

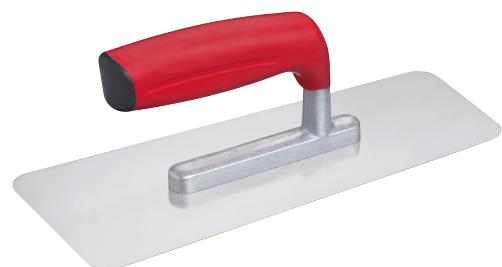

gerade, straight, droit



21.790.01

200x80x0,6mm

30

17443 4

trapezform, trapezium shape, forme trapèze

21.790.06

200x80x0,6mm

30

17844 9

21.790.02

240x100x0,6mm

20

17444 1

21.790.03

280x120x0,6mm

20

17445 8





Kaufmann GmbH
 Tel. +43 5522 73 822
 Fax +43 5522 72 404
 www.kaufmann-tools.at
 office@kaufmann-tools.at

EAN-Code
 90 02648





- DE** Belgische Glättkelle rund
- EN** Belgian smoothing trowel round
- FR** Platoir flamand rond, modèle belge

Ref.	mm		
21.775.02	280x80/100x0,7 mm	50	00774 9
mit durchgehendem Alu-Steg, with continuous aluminium mounting, avec monture en aluminium continue			
21.775.04	450x70/120x1,2 mm	25	00776 3
21.775.05	500x70/120x1,2 mm	25	00777 0
21.775.06	600x70/120x1,2 mm	25	00778 7



- DE** Steinholzglätte/Estrichkelle
- EN** Flooring trowel
- FR** Platoir flamand

Ref.	mm		
21.030.01	400x90x1,2 mm	40	01446 4
21.030.02	450x90x1,2 mm	40	00020 7
21.030.03	500x90x1,2 mm	40	00021 4
21.030.04	600x90x1,2 mm	35	00022 1
21.030.05	700x90x1,2 mm	35	00493 9
21.030.06	800x90x1,2 mm	35	00494 6
21.035.01	400x120x1,2 mm	35	01447 1
21.035.02	450x120x1,2 mm	35	00023 8
21.035.03	500x120x1,2 mm	35	00024 5
21.035.04	600x120x1,2 mm	30	00025 2
21.035.05	700x120x1,2 mm	30	00026 9
21.035.06	800x120x1,2 mm	30	00495 3



Kaufmann GmbH
 Tel. +43 5522 73 822
 Fax +43 5522 72 404
 www.kaufmann-tools.at
 office@kaufmann-tools.at

EAN-Code
 90 02648



DE Steinholzglätte/Estrichkelle rostfrei

EN Flooring trowel stainless

FR Platoir flamand inox

Ref.	mm		
 21.040.01	400x120x1,0 mm	35	01448 8
21.040.02	500x120x1,0 mm	35	00751 0
21.040.03	600x120x1,0 mm	30	00752 7
21.040.05	700x120x1,0 mm	30	18780 9

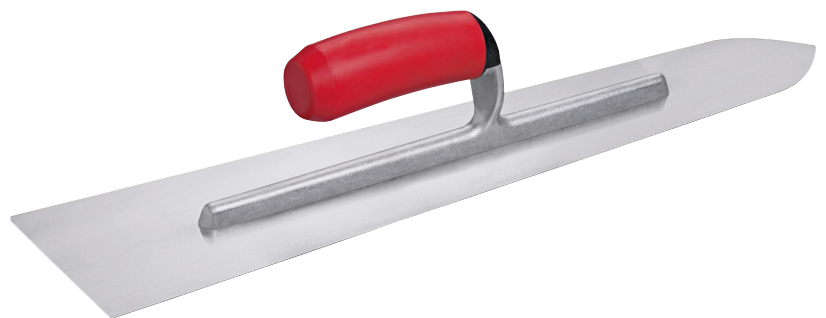

DE Skandinavische Bodenlegerkelle mit Softgriff

EN Scandinavian flooring trowel with softgrip

FR Platoir flamand scandinave avec poignée bi-matière

Ref.	mm		
21.033.01	450x115x0,7 mm	33	18163 0
21.033.02	500x115x0,7 mm	33	18164 7
21.033.03	600x115x0,7 mm	33	18165 4
21.033.04	700x115x0,7 mm	27	18166 1



Kaufmann GmbH
 Tel. +43 5522 73 822
 Fax +43 5522 72 404
 www.kaufmann-tools.at
 office@kaufmann-tools.at

EAN-Code
 9002648.....



- DE** Aufziehglätte KOMPAKT
Griff geschraubt
- EN** Application trowel KOMPAKT
handle screwed
- FR** Taloche KOMPAKT
poignée fixée par vis

Ref.	mm		
rostfrei, stainless, inox			
21.019.20	380x130x0,7mm	10	18018 3



- DE** Aufziehglätte EXPERT
Griff aufgepresst
- EN** Application trowel EXPERT
handle pressed on
- FR** Taloche EXPERT
poignée fixée par pression

Ref.	mm		
rostfrei, stainless, inox			
21.018.03	480x130x0,7mm	25	16524 1



rostfrei, stainless, inox			
21.019.03	480x130x0,7mm	25	16525 8



- DE** Aufziehglätte PROFI
Griff geschraubt
- EN** Application trowel PROFI
handle screwed
- FR** Taloche PROFI
poignée fixée par vis

Ref.	mm		
rostfrei, stainless, inox			
21.018.01	500x130x0,7mm	25	00018 4
21.018.04	500x120x0,5mm	25	16550 0
21.016.01	480x180x1,0mm	6	00016 0



rostfrei, stainless, inox			
21.019.01	500x130x0,7mm	25	00019 1
21.017.01	480x180x1,0mm	6	00017 7



Kaufmann GmbH
 Tel. +43 5522 73 822
 Fax +43 5522 72 404
 www.kaufmann-tools.at
 office@kaufmann-tools.at

EAN-Code
 90 02648



- DE Schweizer Aufziehglätte**
genietet • mit Alu-Steg
- EN Swiss application trowel**
riveted • with continuous aluminium mounting
- FR Taloche suisse**
lame rivetée • avec monture en aluminium

Ref.	mm		
21.020.01	480x130x0,7 mm	6	00821 0
21.020.02 gefast, chamfered, biseautée	480x130x0,7 mm	25	00822 7

rostfrei, stainless, inox



21.021.01	480x130x0,7 mm	25	01430 3
------------------	----------------	----	---------



- DE Weissputzkelle**
mit breitem, geöltem Griff aus Buche gedämpft • geschraubt
- EN Application trowel**
with wide, oiled handle from beech damped • screwed
- FR Taloche**
avec poignée en hêtre tamisée, large • fixée par vis

Ref.	mm		
21.827.02 gefast, chamfered, biseautée	500x140x0,7 mm	20	17239 3



- DE Taloche Suisse rostfrei**
Griff aufgepresst
- EN French application trowel stainless**
handle pressed on
- FR Taloche suisse inox**
poignée fixée par pression

Ref.	mm		
21.712.01	480x140x0,7 mm	20	18250 7





Kaufmann GmbH
Tel. +43 5522 73 822
Fax +43 5522 72 404
www.kaufmann-tools.at
office@kaufmann-tools.at

EAN-Code
90 02648



DE Kardätsche rostfrei

EN Darby float stainless

FR Taloche inox



21.019.27 gefast, chamfered, biseautée

800x130x0,7 mm 18392 4



Kaufmann GmbH
 Tel. +43 5522 73 822
 Fax +43 5522 72 404
 www.kaufmann-tools.at
 office@kaufmann-tools.at

EAN-Code
 90 02648

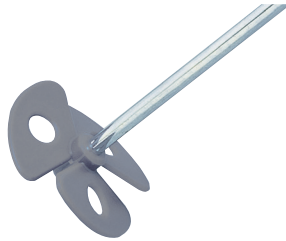

MINI

- DE** Farbrührer mit Kunststoffpropeller und verzinktem Schaft • für flüssige Materialien in kleinen Dosen
- EN** Paintstirrer with plastic propeller and galvanised shaft • for liquid materials in small cans
- FR** Mélangeur avec hélice en plastique et tige galvanisée • pour matériaux liquides en petites récipient

Ref.		mm			
11.001.00	0 - 6 kg	60x350 mm	6 mm	20	00514 1



SPEED

- DE** Rondenrührer • verzinkt • für Lacke, Dispersionsfarben, Tapetenkleister, Vergussmasse, Bitumen
- EN** Round stirrer • galvanised • for lacquer, paint, wallpaper paste, sealing compound, bitumen
- FR** Mélangeur conique • galvanisé • pour laques, vernis, colle pour papier peint, masse de scellement, bitume

Ref.		mm			
11.056.00	0 - 10 kg	70x400 mm	8 mm	12	00831 9
11.058.00	10 - 15 kg	80x400 mm	8 mm	25	00832 6
11.060.00	15 - 20 kg	100x600 mm	10 mm	25	00833 3
11.062.00	20 - 30 kg	120x600 mm	10 mm	18	16572 2
11.562.00	20 - 30 kg	120x600 mm	M14	15	01862 2



TURN

- DE** Wendelrührer ohne Ring • verzinkt • für Fliesenkleber, Fertigputz, Fertigmörtel, Gips, Kalk, Spachtelmasse
- EN** Spiral stirrer without ring • galvanised • for tile adhesive, ready mixed plaster, ready mixed mortar, gypsum, lime, surfacer
- FR** Mélangeur hélicoïdal sans anneau • galvanisé • pour colle à carrelage, enduit et mortier prêt à l'emploi, plâtre, chaux, mastic

Ref.		mm			
11.007.00	5 - 8 kg	70x400 mm	8 mm	25	00718 3
11.009.00	8 - 10 kg	85x500 mm	8 mm	25	00719 0
11.010.00	10 - 15 kg	100x600 mm	10 mm	20	00506 6



Kaufmann GmbH
 Tel. +43 5522 73 822
 Fax +43 5522 72 404
 www.kaufmann-tools.at
 office@kaufmann-tools.at

EAN-Code
 90 02648

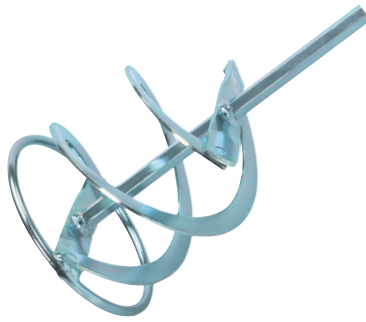

ULTRA

- DE** Wendelrührer mit Ring • verzinkt • für Fliesenkleber, Fertigputz, Fertigmörtel, Gips, Kalk, Spachtelmasse
- EN** Spiral stirrer with ring • galvanised • for tile adhesive, ready mixed plaster, ready mixed mortar, gypsum, lime, surfacer
- FR** Mélangeur hélicoïdal avec anneau • galvanisé • pour colle à carrelage, enduit et mortier prêt à l'emploi, plâtre, chaux, mastic

Ref.					
11.011.00	8- 10 kg	90x500 mm	8 mm	20	16563 0
11.012.00	20-30 kg	120x600 mm	10 mm	15	00720 6
11.013.00	30-40 kg	135x600 mm	10 mm	12	00507 3
11.586.00	10-20 kg	100x600 mm	M 14	20	17155 6
11.512.00	20-30 kg	120x600 mm	M 14	15	01860 8
11.512.18	20-30 kg	120x750 mm	M 14	25	18113 5
11.513.00	30-40 kg	135x600 mm	M 14	12	01861 5
11.516.00	40-50 kg	160x600 mm	M 14	7	00619 3



WHIRL

- DE** Allround-Ringquirl • verzinkt • zum Mischen von flüssigen und zähen Materialien • ideal für den Heimwerker
- EN** Ring-stirrer • galvanised • for mixing liquid and viscous materials • ideal for do-it-yourselfer
- FR** Mélangeur à anneaux • galvanisé • pour mélanger les matériaux liquides et visqueux • idéal pour bricoleurs

Ref.					
11.039.00	5- 15 kg	85x500 mm	8 mm	20	00620 9

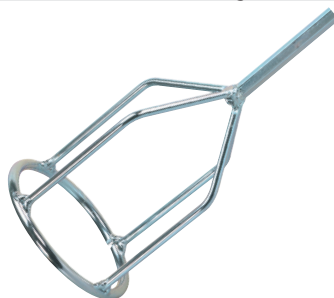

LIGHT

- DE** Korbrührer • verzinkt • verhindert das Einmischen von Luft • für Verguss- und Dichtmassen, Haftemulsion, Fliesen- und Baukleber, Spachtelmasse
- EN** Basket-stirrer • galvanised • prevent to mix in air • for sealing compound, bonding emulsion, tile and building adhesive, surfacer
- FR** Mélangeur en forme de fouet • galvanisé • évite de mêler l'air au matériau • pour masses de scellement et d'étanchéité, émulsion adhésive, colle à carrelage et de construction, mastic

Ref.					
11.020.00	8- 10 kg	90x600 mm	8 mm	24	16878 5



Kaufmann GmbH
 Tel. +43 5522 73 822
 Fax +43 5522 72 404
 www.kaufmann-tools.at
 office@kaufmann-tools.at

EAN-Code
 9002648.....

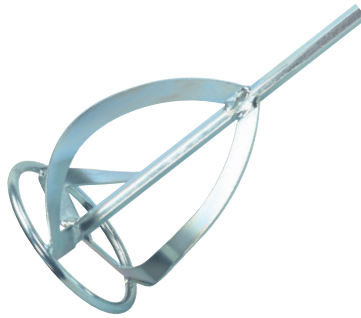

PRO

- DE** Mörtelrührer • verzinkt • für Farben, Fertigputz, Estrich, Beton, Zement, Kalk, Dicht- und Spachtelmasse
- EN** Mortar stirrer • galvanised • for paints, ready-mixed plaster, screed, concrete, cement, lime, sealant, surfacer
- FR** Mélangeur mortier • galvanisé • pour vernis, enduit prêt à l'emploi, chape, béton, ciment, chaux, masse d'étanchéité, mastic

Ref.					
11.175.00	15-25 kg	120x600 mm	12 mm	15	16618 7
11.575.00	15-25 kg	120x600 mm	M 14	15	16619 4

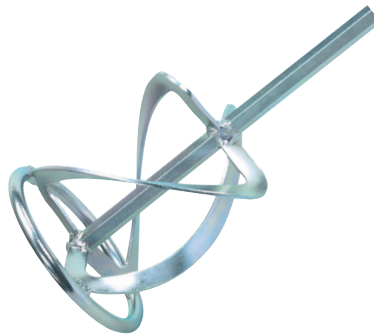

PRO SPEZIAL

- DE** Mörtelrührer • verzinkt • für Mörtel, Fertigputz, Estrich, Beton, Zement, Kalk, Dicht- und Spachtelmasse
- EN** Mortar stirrer • galvanised • for mortar, ready-mixed plaster, screed, concrete, cement, lime, sealant, surfacer
- FR** Mélangeur mortier • galvanisé • pour mortier, enduit prêt à l'emploi, chape, béton, ciment, chaux, masse d'étanchéité, mastic

Ref.					
11.588.00	15-25 kg	120x600 mm	M 14	10	16948 5
11.588.10	15-25 kg	120x750 mm	M 14	25	19033 5
11.589.00	25-40 kg	140x600 mm	M 14	10	16949 2
11.589.10	25-40 kg	140x750 mm	M 14	16	19032 8
11.590.00	30-60 kg	160x600 mm	M 14	6	16927 0



Kaufmann GmbH
 Tel. +43 5522 73 822
 Fax +43 5522 72 404
 www.kaufmann-tools.at
 office@kaufmann-tools.at

EAN-Code
 90 02648

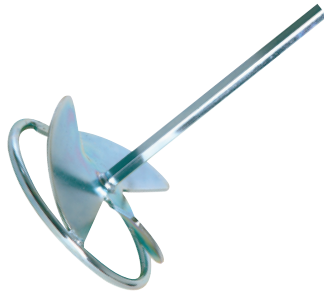

EXPRESS

DE Handwerkerquirl • verzinkt • mit gebindeschonendem Ring • schnelle Materialmischung (nach unten) durch optimale Propellerform • für Mörtel, Fertigputz, Beton, Estrich, Kalk, Dicht- und Spachtelmasse, Lacke, Farben, Fliesenkleber, Haftemulsion, Vergussmasse

EN Stirrer for the professional • galvanised • with bucket protective ring • fast mixing of the material (downwards) as a result of an optimal shape of the propellers • for mortar, ready-mixed plaster, concrete, screed, lime, sealant, surfacer, lacquer, paint, tile adhesive, bonding emulsion, sealing compound

FR Mélangeur pour professionnel • galvanisé • avec seau-protective anneaux • mélange rapide du matériel (vers bas) à cause de la forme optimale de l'hélice • pour mortier, enduit prêt à l'emploi, béton, chape, chaux, masse d'étanchéité, mastic, laques, vernis, colle à carrelage, émulsion adhésive, masse de scellement

Ref.					
11.036.00	20-25 kg	140x600 mm	11 mm	12	18109 8
11.536.00	20-35 kg	140x600 mm	M 14	12	18110 4

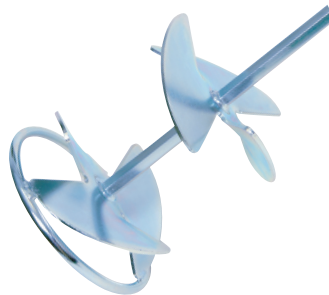

TURBO

DE Handwerkerquirl • verzinkt • mit gebindeschonendem Ring • schnelle Materialmischung durch gegenläufige Propellerform • für Mörtel, Fertigputz, Beton, Estrich, Kalk, Dicht und Spachtelmasse, Fliesen- und Baukleber, Zement, Wärmedämmputz, Dispersion

EN Stirrer for the professional • galvanised • with bucket protective ring • fast mixing of the material as a result of counter rotating propellers • for mortar, ready-mixed plaster, concrete, screed, lime, sealant, surfacer, tile and building adhesive, cement, heat insulation plaster, dispersion

FR Mélangeur pour professionnel • galvanisé • avec seau-protective anneaux • mélange rapide du matériel à cause de la forme opposée de l'hélice • pour mortier, enduit prêt à l'emploi, béton, chape, chaux, masse d'étanchéité, mastic, colle à carrelage et de construction, ciment, crépi d'isolation thermique, dispersion

Ref.					
11.037.00	20-30 kg	140x600 mm	11 mm	10	18111 1
11.537.00	25-40 kg	140x600 mm	M 14	10	18112 8



Kaufmann GmbH
 Tel. +43 5522 73 822
 Fax +43 5522 72 404
 www.kaufmann-tools.at
 office@kaufmann-tools.at





EAN-Code
 90 02648

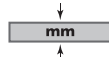

DE FliesenlochBoy
 aus Alu-Druckguss • für Wand- und Bodenfliesen aus Steingut • nicht geeignet für Feinsteinzeug

EN Tile-hole device
 made of die-cast aluminium • for wall and floor tiles made of earthenware • not suitable for porcelain stoneware

FR Dispositif de perforation pour carreaux
 en aluminium coulé sous pression • pour carreaux muraux et de sol en faïence • non utilisable pour le grès-cérame

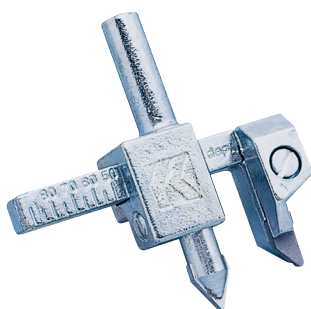

Ref.					
12.312.20	330 mm	20 mm	40 mm	25	16691 0

DE Fliesenlochbohrer SOLID
 Hartmetallspitze und -schneiden auswechselbar • für Wand- und Bodenfliesen aus Steingut • nicht geeignet für Klinker, Steinzeug und Feinsteinzeug

EN Tile-hole borer SOLID
 replaceable tungsten carbide tip and cutters • for wall and floor tiles made of earthenware • not suitable for clinker, stoneware and porcelain stoneware

FR Perce-carreaux SOLID
 pointe et lames au carbure de tungstène échangeables • pour carreaux muraux et de sol en faïence • non utilisable pour les briques recuites, le grès et grès-cérame

Ref.			
SB-verpackt, self-service packed, emballage self-service 12.465.02	23-94 mm	12	00455 7
lose, bulk, en vrac 12.465.03	23-94 mm	50	00469 4

Hartmetall-Spitze und 2 Schneiden / Tungsten carbide tip and 2 cutters / Pointe et 2 lames au carbure de tungstène

SB-verpackt, self-service packed, emballage self-service 12.499.01	00466 3
--	---------



Kaufmann GmbH
 Tel. +43 5522 73 822
 Fax +43 5522 72 404
 www.kaufmann-tools.at
 office@kaufmann-tools.at

EAN-Code
 90 02648



DE Steckdosenschneider



mit 3 Schnellwechseleinsätzen • HSS-Spezialbohrer mit Sechskantschaft • für alle Bohrmaschinen geeignet • für den Innenausbau, Holz und Gipskarton

EN Power socked cutter

with 3 exchangeable saw-inserts • hexagon shaft high speed drill • can be used with all drill motors • for interior work, wood and gypsum board

FR Scies-cloches

avec 3 scies échangeables • foret HSS avec tige hexagonale • s'adapte sur toute perceuse • pour travaux d'intérieur, bois et placoplâtre

Ref.			
SB-verpackt, self-service packed, emballage self-service			
26.100.01	60/67/74 mm	32 mm	00150 1
26.110.01	72/80/95 mm	32 mm	00160 0
lose, bulk, en vrac			
26.100.02	60/67/74 mm	32 mm	00708 4
26.110.02	72/80/95 mm	32 mm	00710 7



Kaufmann GmbH
 Tel. +43 5522 73 822
 Fax +43 5522 72 404
 www.kaufmann-tools.at
 office@kaufmann-tools.at

EAN-Code
 90 02648

- DE Fasenhobel für Stuckateure**
aus Holz • mit 10 Stahlklingen
- EN Router for plasterers**
made of wood • with 10 steel-blades
- FR Rabet à chanfrein pour stucateurs**
en bois • avec 10 lames en acier



Ref.	mm	kg	EAN
Dreieckzahn, triangle teeth, dents triangulaires 25.140.00		0,39 kg	16594 4
Halbzahn, half teeth, demi-dents 25.143.00		0,39 kg	16595 1
Vollzahn, full teeth, dents rectangulaires 25.146.00		0,39 kg	16596 8

- DE Deckensäge/Stucksäge**
aus Holz • mit gehärtetem Stahlblatt • gezahnt
- EN Ceiling saw/plasterer saw**
made of wood • with hardened steel-blade • notched
- FR Scie de plafond/scie de stucateur**
en bois • avec lame en acier trempé • dentée



Ref.	mm	mm	kg	EAN
25.160.00	320 mm	8 mm	0,54 kg	16598 2
25.160.24	320 mm	4 mm	0,54 kg	17573 8
Ersatzblatt / Replacement blade / Lame de rechange				
25.161.00	320 mm	8 mm	0,22 kg	16609 5
25.161.24	320 mm	4 mm	0,22 kg	17574 5



Kaufmann GmbH
 Tel. +43 5522 73 822
 Fax +43 5522 72 404
 www.kaufmann-tools.at
 office@kaufmann-tools.at

EAN-Code
 90 02648



DE Kleiner Gipserhobel
 mit Holzgriff und 6 Stahlklingen • zum Nachbearbeiten
 oder Egalisieren von Putzen

EN Small wall plane
 with wooden handle and 6 steel-blades • for reworking or equalising of plasters

FR Petit rabot à plâtre
 avec manche en bois et 6 lames en acier • pour retoucher ou égaliser les enduits

Ref.	mm	kg		
42.111.01	330x40 mm	0,40 kg	26	00111 2
mit Alu-Anschlag, with aluminium stop, avec réglette en aluminium				
42.111.50	330x40 mm	0,50 kg	20	18557 7

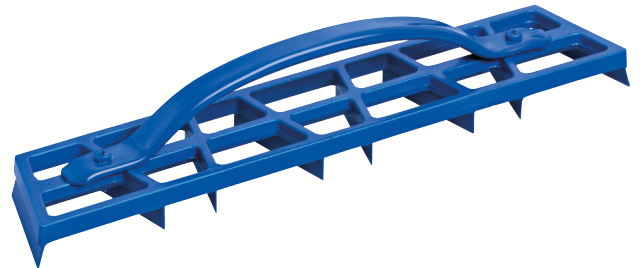

DE Alu-Gipserhobel
 mit Stahlgriff und 8 Stahlklingen • zum
 Nachbearbeiten oder Egalisieren von Putzen

EN Aluminium wall plane
 with steel handle and 8 steel-blades • for reworking or equalising of plasters

FR Rabot à plâtre en aluminium
 avec manche et 8 lames en acier • pour retoucher ou égaliser les enduits

Ref.	mm	kg		
25.110.01	460x85 mm	0,91 kg	15	00110 5



Kaufmann GmbH
Tel. +43 5522 73 822
Fax +43 5522 72 404
www.kaufmann-tools.at
office@kaufmann-tools.at

EAN-Code
90 02648

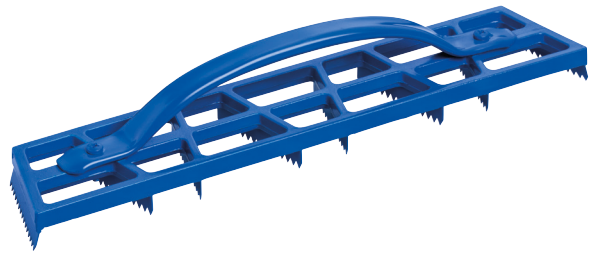

DE Porenbeton-Raspelhobel

aus Aluminium • sehr robust • mit 8 Sägezähnen aus Stahl • zum Abschleifen und Ausgleichen von Porenbetonsteinen

EN Plane for cellular concrete

made of aluminium • very robust • with 8 saw teeth made of steel • for grinding and equalising aerated concrete blocks

FR Rabot pour béton cellulaire

en aluminium • très robuste • avec 8 lames dentées en acier • pour abraser et égaliser les briques en béton cellulaire

45.637.01	460x85 mm	0,80 kg	15	17952 1



Kaufmann GmbH
 Tel. +43 5522 73 822
 Fax +43 5522 72 404
 www.kaufmann-tools.at
 office@kaufmann-tools.at

EAN-Code
 90 02648

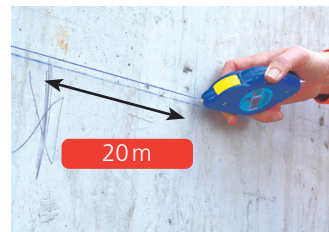

DE Schlagschnurgerät MASTER

professionelles Schlagschnurgerät von Kaufmann • hochwertiges Gehäuse aus Aluminium-Druckguss • mit Metallspitze, kann auch als Senklot verwendet werden • grosse Einfüllöffnung mit weichem Gummiverschluss für ein einfaches und sauberes Befüllen • 20Meter Schnur mit hoher Reissfestigkeit und optimaler Pulveraufnahme • spezieller Schnurhaken mit Krallen

EN Chalk line marker MASTER

professional chalk line marker from Kaufmann • high-quality body made of die-cast aluminium • with metal point, can also be used as a plumb-bob • large opening with soft rubber-closure for an easy and clean filling • 20 meter cord with a high tear strength and optimal absorption of powder • special hook with claw

FR Cordeau traceur MASTER

cordeau traceur professionnel de la marque Kaufmann • boîtier de haute qualité en aluminium coulé sous pression • avec pointe en métal, pour utilisation aussi comme fil à plomb • large ouverture avec fermeture en caoutchouc pour remplissage facile et propre • cordeau de 20 mètres avec haute résistance et absorption optimale • crochet spécial avec griffe

Ref.	m	Barcode
40.120.01	20m	00120 4

SB-verpackt mit 1 Beutel Farbpuder blau, self-service packed with 1 pouch colour powder blue, emballé self-service avec 1 sachet de poudre de traçage bleu

40.120.02	20m	00119 8
-----------	-----	---------



DE Ersatzschnur zu Schlagschnurgerät Master/SpeedMaster

EN Replacement cord for chalk line marker Master/SpeedMaster

FR Cordeau de rechange pour cordeau traceur Master/SpeedMaster

Ref.	m	Barcode
40.123.01 ohne Haken, without hook, sans crochet	25m	00123 5
40.123.02 mit Haken, with hook, avec crochet	25m	00885 2



Kaufmann GmbH
Tel. +43 5522 73 822
Fax +43 5522 72 404
www.kaufmann-tools.at
office@kaufmann-tools.at

EAN-Code
90 02648



DE Schlagschnurgerät MASTER, SB-verpackt

mit Farbpuder blau 100 g • professionelles Schlagschnurgerät von Kaufmann • hochwertiges Gehäuse aus Aluminium-Druckguss • mit Metallspitze, kann auch als Senklot verwendet werden • grosse Einfüllöffnung mit weichem Gummiverschluss für ein einfaches und sauberes Befüllen • 20 Meter Schnur mit hoher Reissfestigkeit und optimaler Pulveraufnahme • spezieller Schnurhaken mit Krallen

EN Chalk line marker MASTER, self-service packed

with colour powder blue 100 g • professional chalk line marker from Kaufmann • high-quality body made of die-cast aluminium • with metal point, can also be used as a plumb-bob • large opening with soft rubber-closure for an easy and clean filling • 20 meter cord with a high tear strength and optimal absorption of powder • special hook with claw

FR Cordeau traceur MASTER, emallage self-service

avec poudre de traçage bleu 100 g • cordeau traceur professionnel de la marque Kaufmann • boîtier de haute qualité en aluminium coulé sous pression • avec point en métal, pour utilisation aussi comme fil à plomb • large ouverture avec fermeture en caoutchouc pour remplissage facile et propre • cordeau de 20 mètres avec haute résistance et absorption optimale • crochet spécial avec griffe

40.120.03	20m	1	19152 3



Kaufmann GmbH
 Tel. +43 5522 73 822
 Fax +43 5522 72 404
 www.kaufmann-tools.at
 office@kaufmann-tools.at

EAN-Code
 90 02648



DE Schlagschnurgerät SPEEDMASTER

professionelles Schlagschnurgerät von Kaufmann • ergonomisches Design • hochwertiges Gehäuse aus glasfaser-verstärktem Kunststoff • kugelgelagertes Planetengetriebe, verschleiss- und wartungsfrei • Übersetzung für 3 mal schnelleren Schnureinzug • Getriebekammer abgedichtet und von Pulverkammer getrennt • grosse Einfüllöffnung mit weichem Gummiverschluss für ein einfaches und sauberes Befüllen • 25 Meter Schnur mit hoher Reißfestigkeit und optimaler Pulveraufnahme • spezieller Schnurhaken mit Kralle

EN Chalk line marker SPEEDMASTER

professional chalk line marker from Kaufmann • ergonomic design • high-quality body made of plastic strengthened with fibre glass • ball bearing planetary gear, wearing and maintenance-free • speed transformation for 3 times faster rolling-up • gear housing sealed and separated from powder housing • large opening with soft rubber-closure for an easy and clean filling • 25 meter cord with a high tear strength and optimal absorption of powder • special hook with claw

FR Cordeau traceur SPEEDMASTER

cordeau traceur professionnel de la marque Kaufmann • design ergonomique • boîtier de haute qualité en plastique renforcé par de la fibre de verre • train épicycloïdal à roulement à billes, sans usure ni entretien • transformation pour un enroulement 3 fois plus rapide • boîtier d'engrenage étanche et séparé de la réserve de poudre • large ouverture avec fermeture en caoutchouc pour un remplissage facile et propre • cordeau de 25 mètres avec haute résistance et absorption optimale • crochet spécial avec griffe

Ref.	m	
40.130.01	25 m	18252 1
SB-verpackt mit 1 Flasche Farbpuder blau, self-service packed with 1 bottle colour powder blue, emballé self-service avec 1 flacon de poudre de traçage bleu		
40.130.02	25 m	18253 8



8 Stück im Display-Karton, 8 pieces in display-box, présentoir de 8 pièces

40.131.01	25 m	18252 1
-----------	------	---------



Kaufmann GmbH
Tel. +43 5522 73 822
Fax +43 5522 72 404
www.kaufmann-tools.at
office@kaufmann-tools.at

EAN-Code
90 02648

DE Verkaufsständer

für alle Modelle Fliesenschneidmaschinen bis 920mm Schnittlänge • 1,9m hoch (mit Räder 1,935m) • Grundplatte 120x45cm, Fächer 101x35cm und 91x35cm • fixierbare Räder • Broschürenhalter

EN Display stand

for all models tile cutting machines up to a cutting length of 920 mm • 1,9m high (with wheels 1,935 m) • base plate 120x45 cm, shelves 101x35cm and 91x35 cm • fixable wheels • brochure display

FR Présentoir

pour tous modèles machines coupe-carreaux jusqu'à une longueur de coupe de 920 mm • 1,9m de haut (avec roulettes 1,935 m) • socle 120x45cm, étagères 101x35 cm et 91x35 cm • roulettes fixables • porte-brochures

Ref.

kg

71.060.02 mit 4 Fächern / with 4 shelves / avec 4 étagères

34,4kg

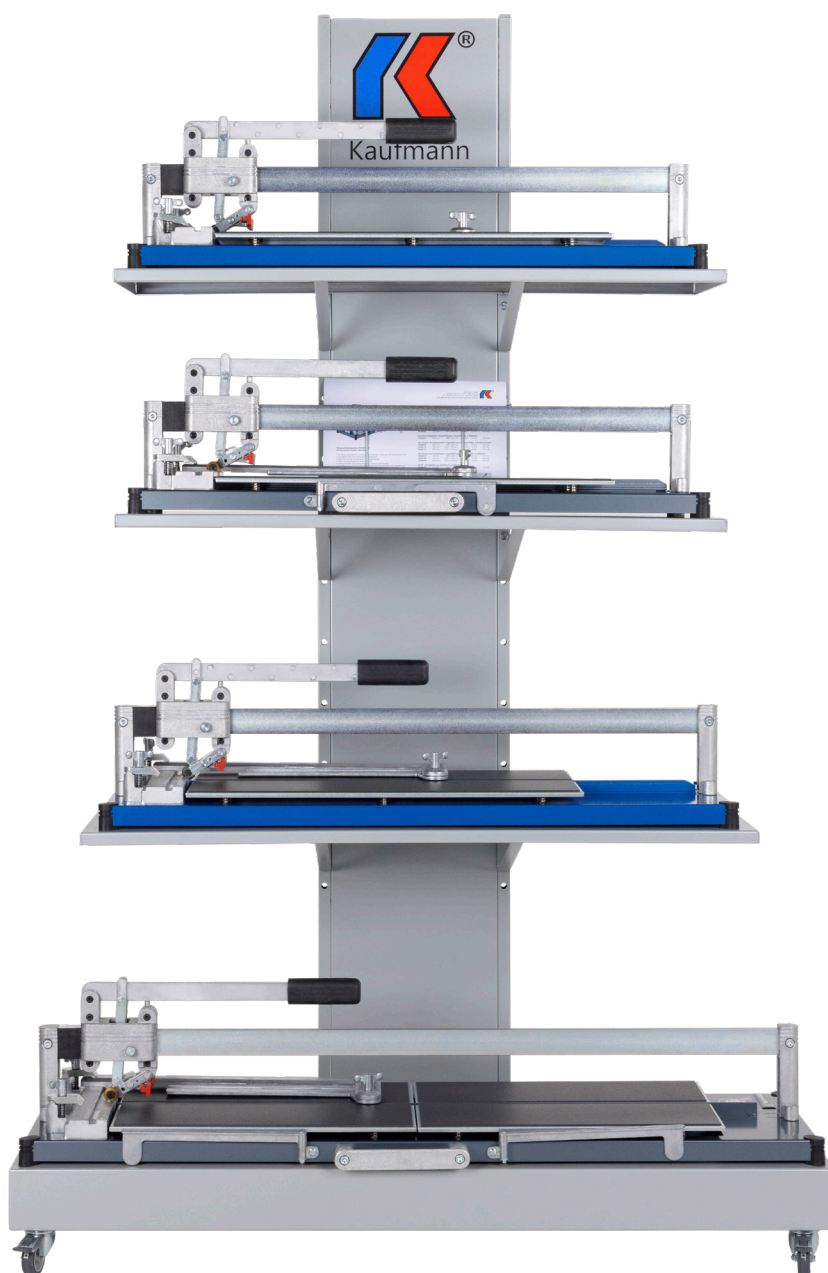



Kaufmann GmbH
Tel. +43 5522 73 822
Fax +43 5522 72 404
www.kaufmann-tools.at
office@kaufmann-tools.at

EAN-Code
90 02648

DE Explosionszeichnung Fliesenschneidmaschine Superflies
Schnittlänge 600 mm

EN Exploded drawing tile cutting machine Superflies
cutting length 600 mm

FR Vue éclatée machine coupe carreaux Superflies
longueur de coupe 600 mm

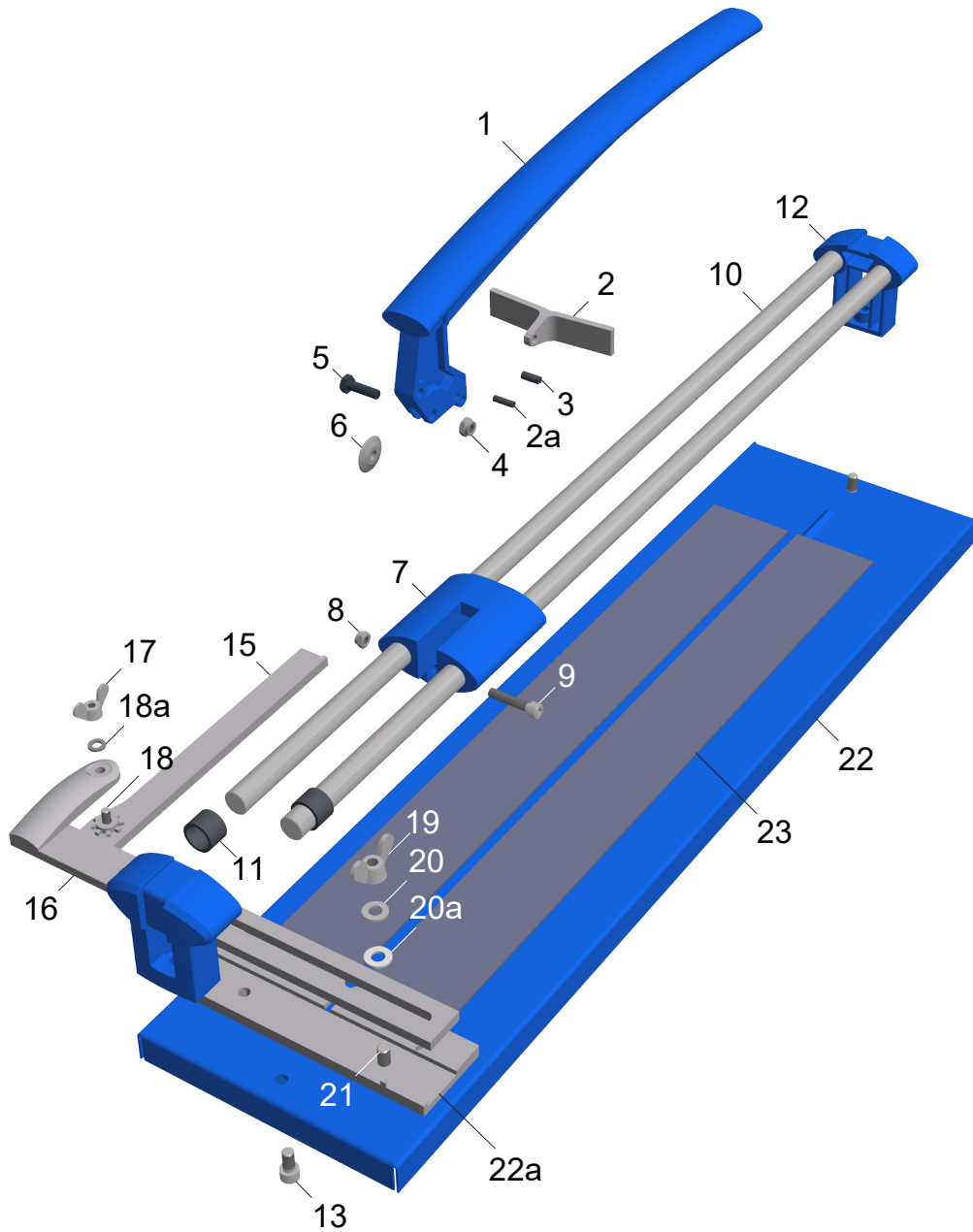



Kaufmann GmbH
 Tel. +43 5522 73 822
 Fax +43 5522 72 404
 www.kaufmann-tools.at
 office@kaufmann-tools.at

EAN-Code
 90 02648

DE Explosionszeichnung Fliesenschneidmaschine TopLine STANDARD

Schnittlängen 480 mm, 630 mm, 720 mm, 920 mm

EN Exploded drawing tile cutting machine TopLine STANDARD

cutting lengths 480 mm, 630 mm, 720 mm, 920 mm

FR Vue éclatée machine coupe carreaux TopLine STANDARD

longueurs de coupe 480 mm, 630 mm, 720 mm, 920 mm

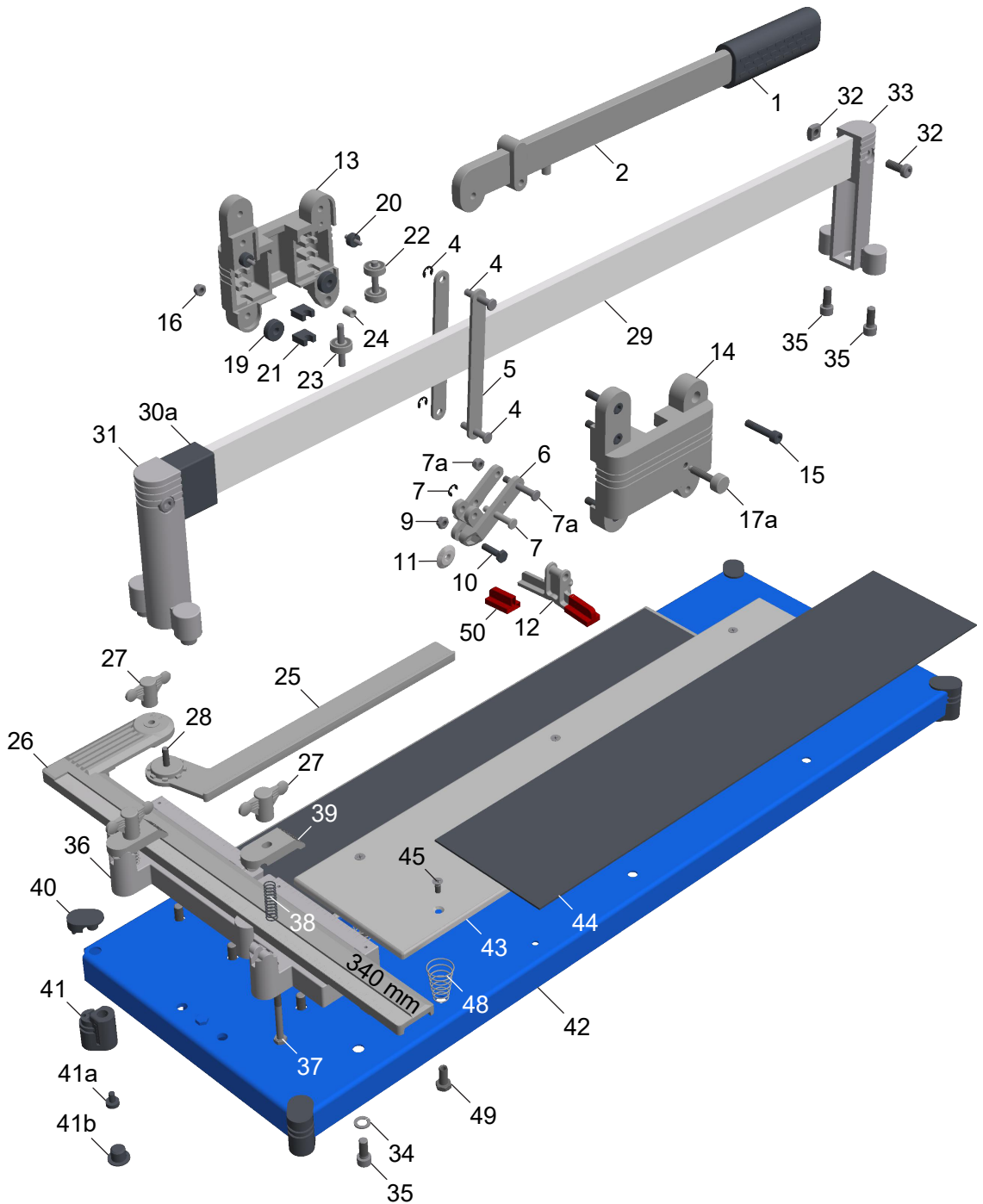



Kaufmann GmbH
 Tel. +43 5522 73 822
 Fax +43 5522 72 404
 www.kaufmann-tools.at
 office@kaufmann-tools.at

EAN-Code
 90 02648

DE Explosionszeichnung Fliesenschneidmaschine TopLine STANDARD mit 2 Führungsschienen
 Schnittlänge 1250 mm

EN Exploded drawing tile cutting machine TopLine STANDARD with 2 guide rails
 cutting length 1250 mm

FR Vue éclatée machine coupe carreaux TopLine STANDARD avec 2 rails de guidage
 longueur de coupe 1250 mm

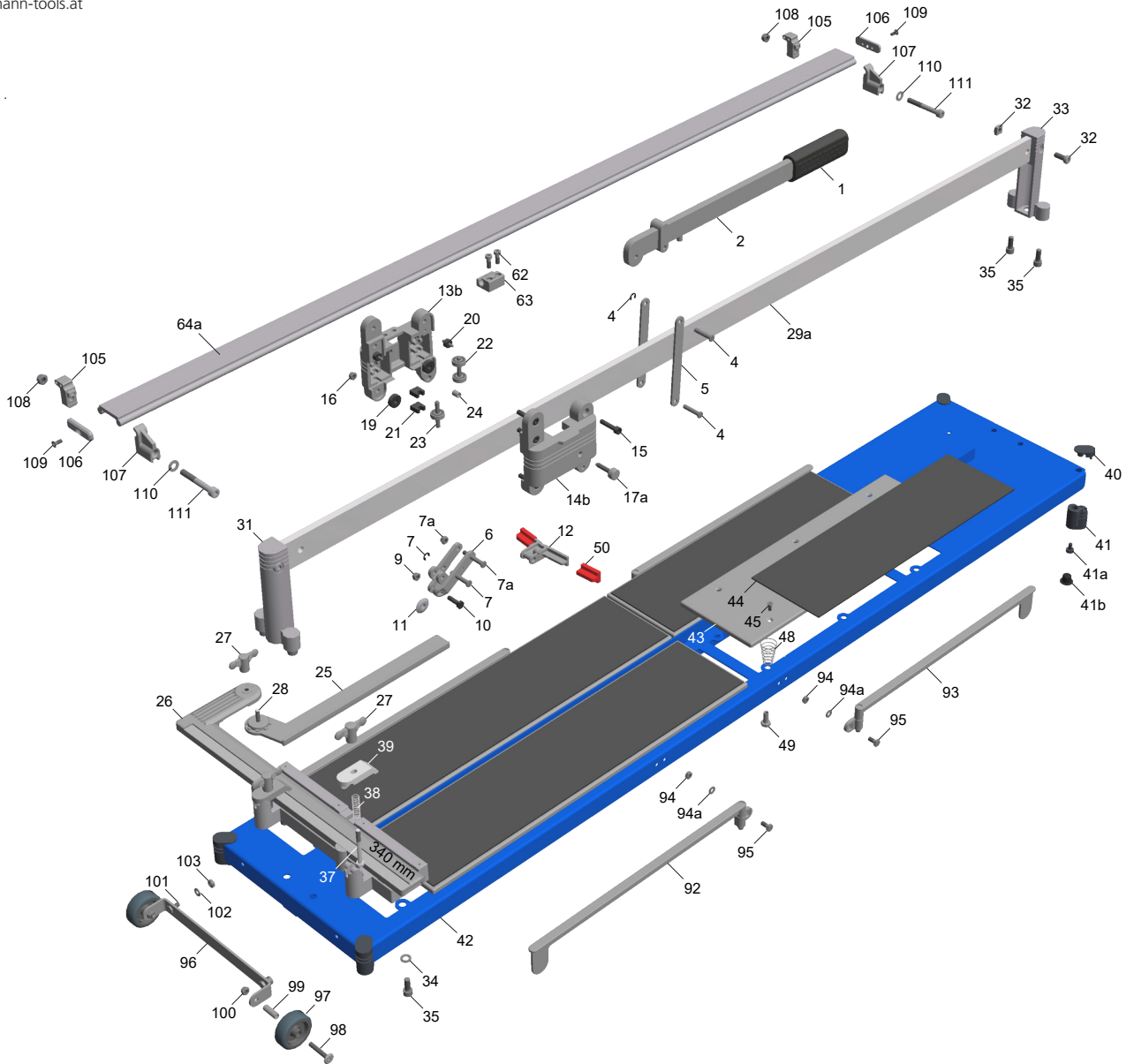



Kaufmann GmbH
 Tel. +43 5522 73 822
 Fax +43 5522 72 404
 www.kaufmann-tools.at
 office@kaufmann-tools.at

EAN-Code
 90 02648

DE Explosionszeichnung Fliesenschneidmaschine TopLine ROCK
 Schnittlängen 630 mm, 720 mm, 920 mm

EN Exploded drawing tile cutting machine TopLine ROCK
 cutting lengths 630 mm, 720 mm, 920 mm

FR Vue éclatée machine coupe carreaux TopLine ROCK
 longueurs de coupe 630 mm, 720 mm, 920 mm

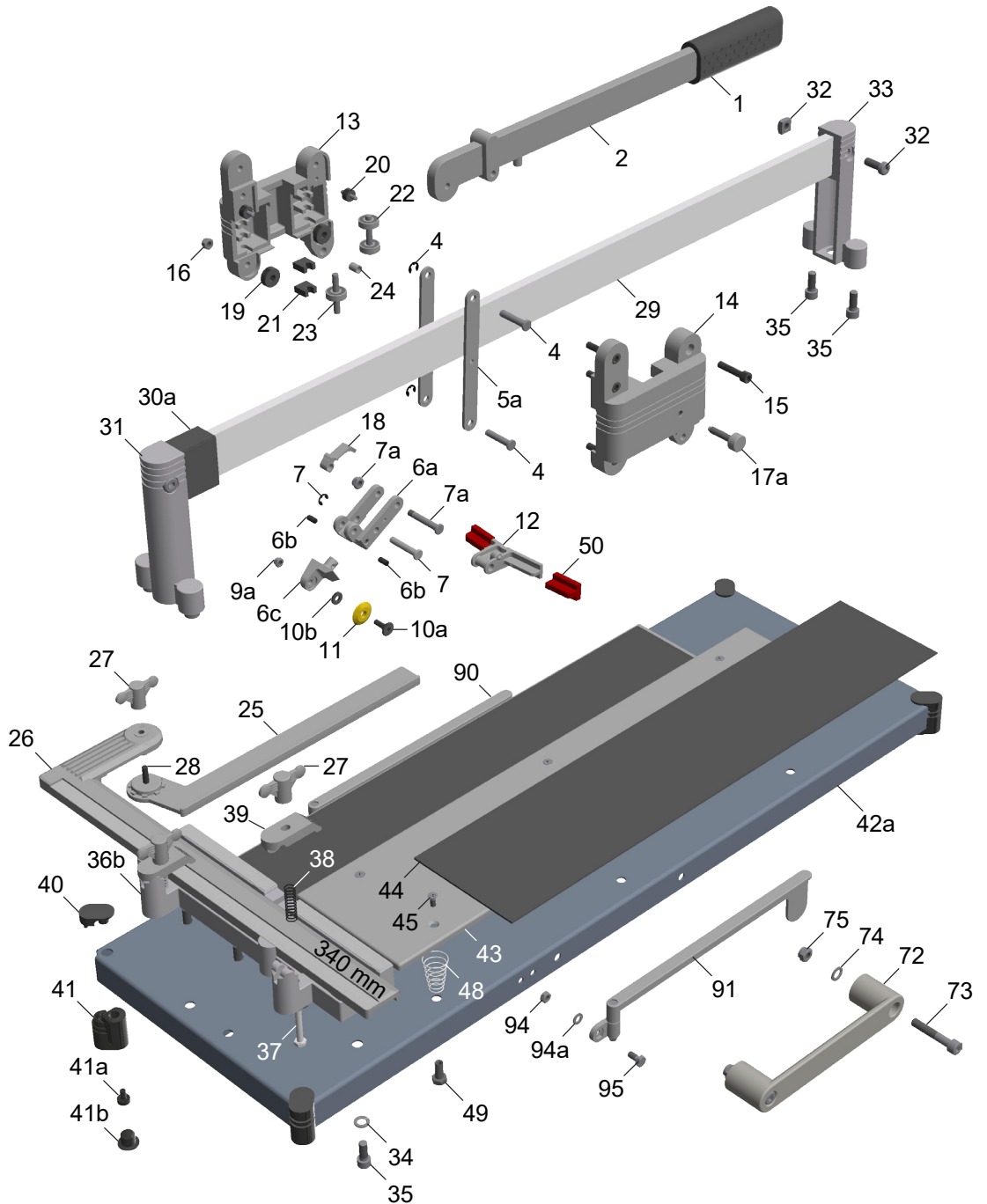



Kaufmann GmbH
Tel. +43 5522 73 822
Fax +43 5522 72 404
www.kaufmann-tools.at
office@kaufmann-tools.at

EAN-Code
90 02648

DE Explosionszeichnung Fliesenschneidmaschine TopLine ROCK mit 2 Führungsschienen
Schnittlängen 920 mm, 1250 mm

EN Exploded drawing tile cutting machine TopLine ROCK with 2 guide rails
cutting lengths 920 mm, 1250 mm

FR Vue éclatée machine coupe carreaux TopLine ROCK avec 2 rails de guidage
longueurs de coupe 920 mm, 1250 mm

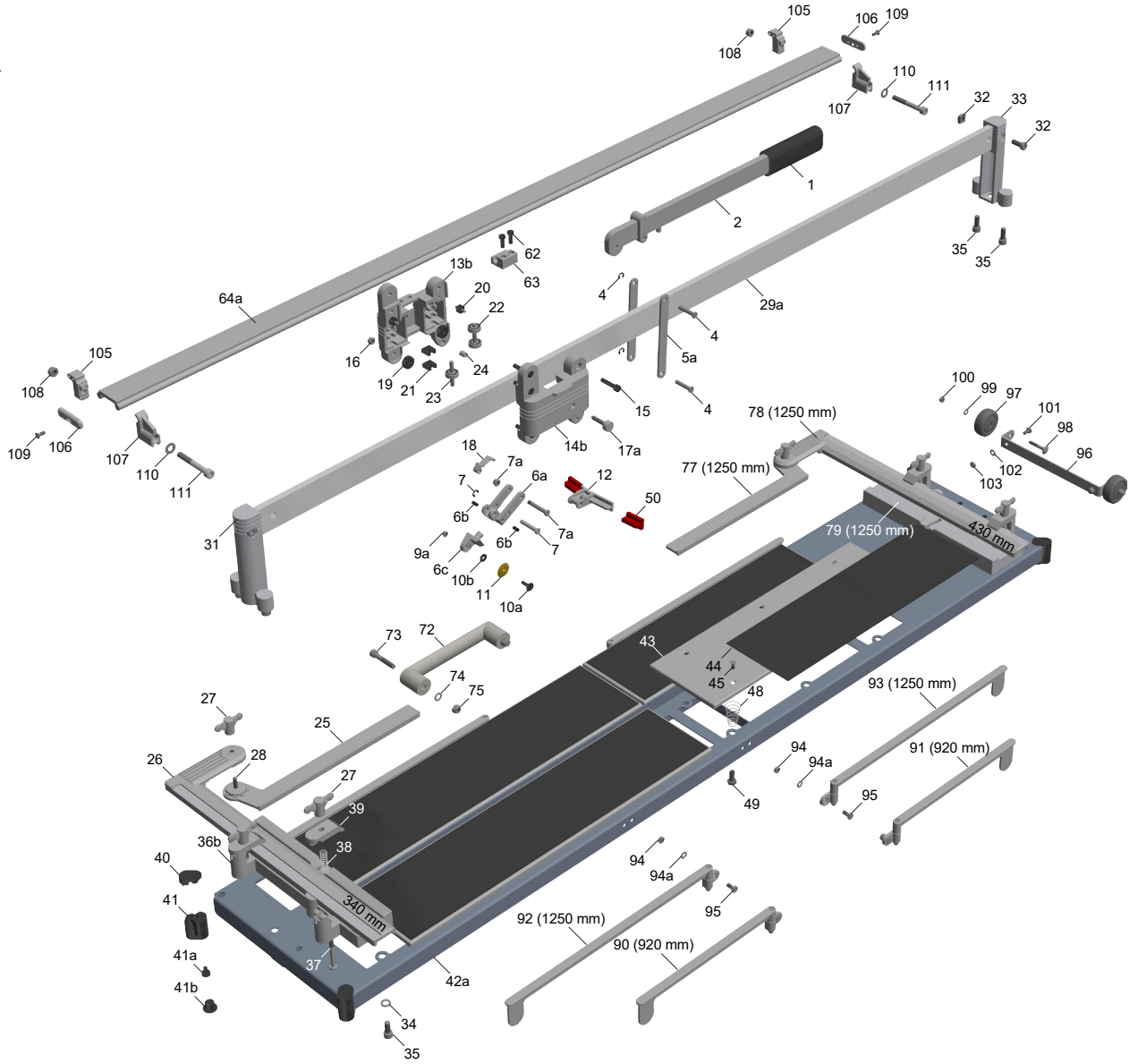



Kaufmann GmbH
Tel. +43 5522 73 822
Fax +43 5522 72 404
www.kaufmann-tools.at
office@kaufmann-tools.at

EAN-Code
90 02648

DE Explosionszeichnung Fliesenschneidmaschine TopLine TWIST
Schnittlängen 630 mm, 720 mm, 920 mm

EN Exploded drawing tile cutting machine TopLine TWIST
cutting lengths 630 mm, 720 mm, 920 mm

FR Vue éclatée machine coupe carreaux TopLine TWIST
longueurs de coupe 630 mm, 720 mm, 920 mm

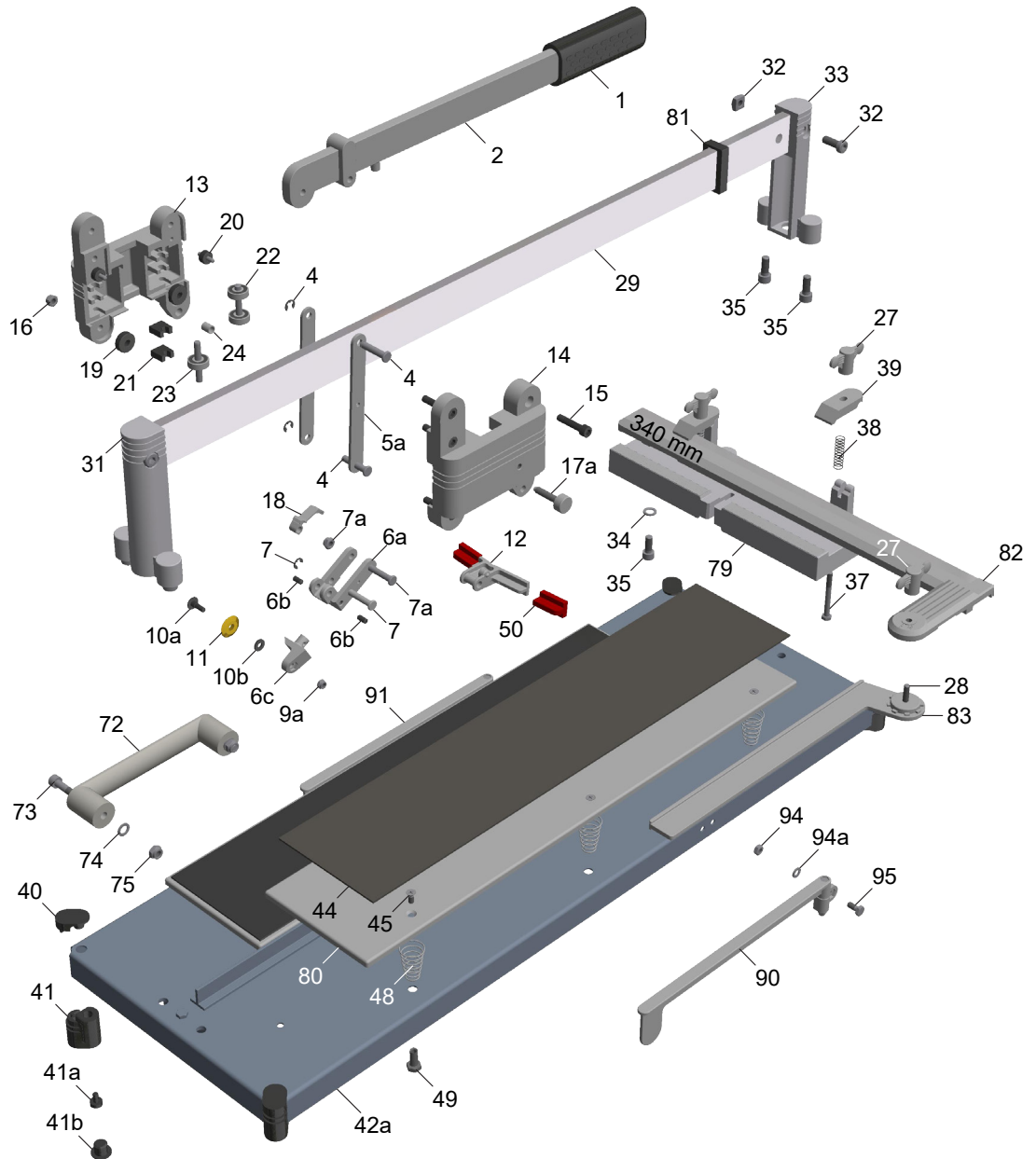



Kaufmann GmbH
 Tel. +43 5522 73 822
 Fax +43 5522 72 404
 www.kaufmann-tools.at
 office@kaufmann-tools.at

DE Explosionszeichnung Fliesenschneidmaschine TopLine TWIST mit 2 Führungsschienen
 Schnittlängen 920 mm, 1250 mm

EN Exploded drawing tile cutting machine TopLine TWIST with 2 guide rails
 cutting lengths 920 mm, 1250 mm

FR Vue éclatée machine coupe carreaux TopLine TWIST avec 2 rails de guidage
 longueurs de coupe 920 mm, 1250 mm

EAN-Code
 90 02648

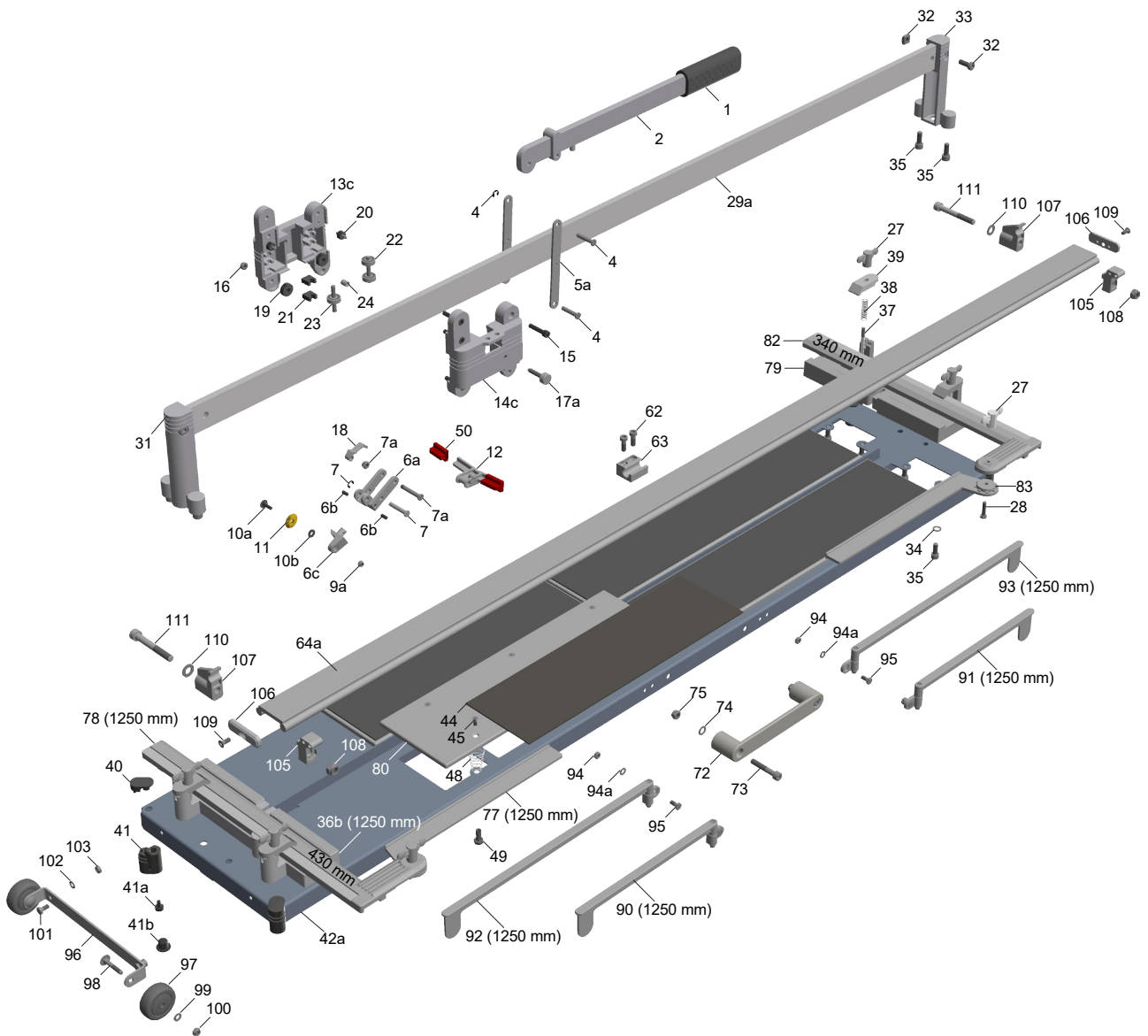



Kaufmann GmbH
Tel. +43 5522 73 822
Fax +43 5522 72 404
www.kaufmann-tools.at
office@kaufmann-tools.at

EAN-Code
90 02648

DE Explosionszeichnung Fliesenschneidmaschine TopLine PRO
Schnittlängen 630 mm, 720 mm, 920 mm

EN Exploded drawing tile cutting machine TopLine PRO
cutting lengths 630 mm, 720 mm, 920 mm

FR Vue éclatée machine coupe carreaux TopLine PRO
longueurs de coupe 630 mm, 720 mm, 920 mm

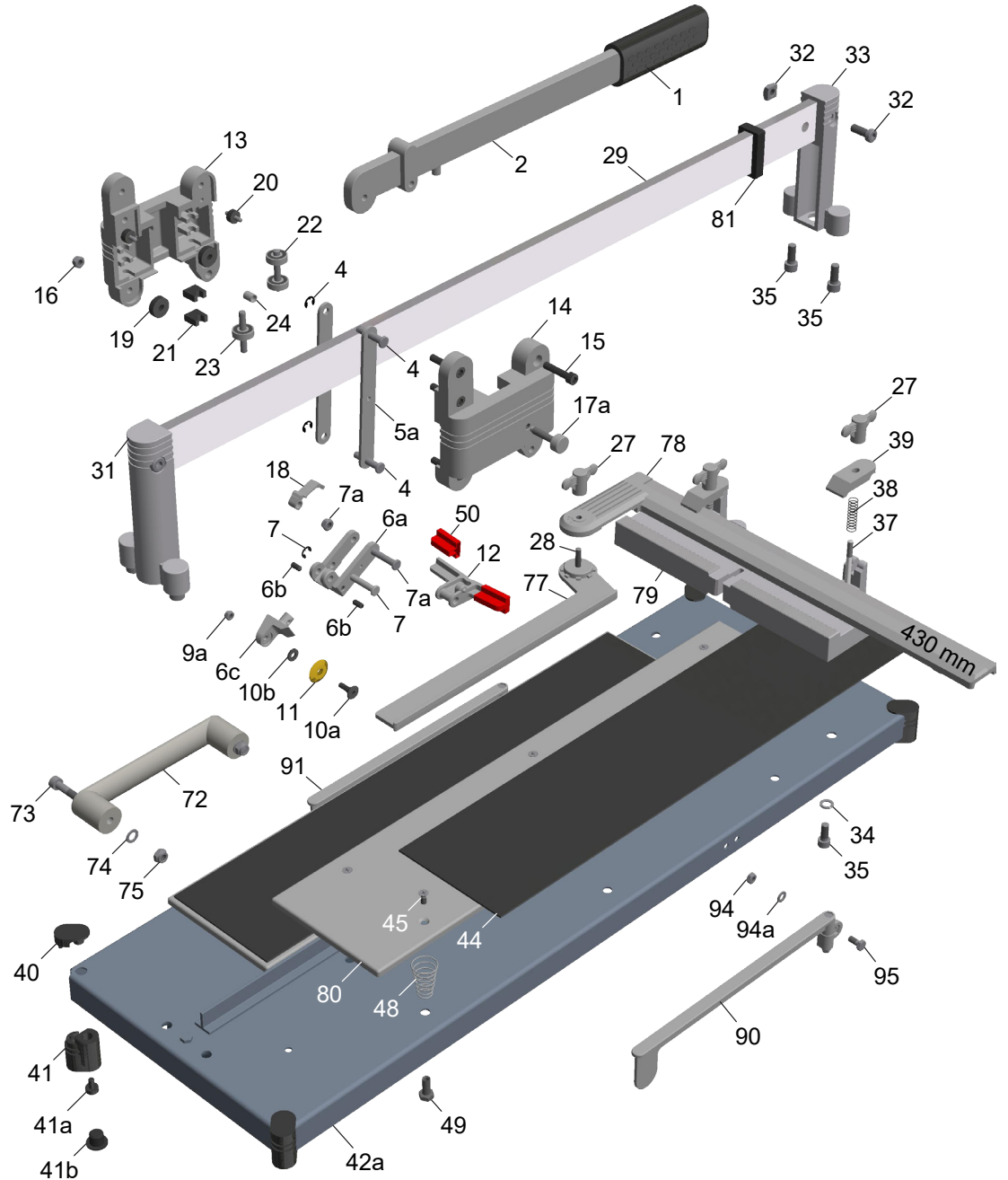



Kaufmann GmbH
 Tel. +43 5522 73 822
 Fax +43 5522 72 404
 www.kaufmann-tools.at
 office@kaufmann-tools.at

DE Explosionszeichnung Fliesenschneidmaschine TopLine PRO mit 2 Führungsschienen
 Schnittlängen 920 mm, 1250 mm

EN Exploded drawing tile cutting machine TopLine PRO with 2 guide rails
 cutting lengths 920 mm, 1250 mm

FR Vue éclatée machine coupe carreaux TopLine PRO avec 2 rails de guidage
 longueurs de coupe 920 mm, 1250 mm

EAN-Code
 90 02648

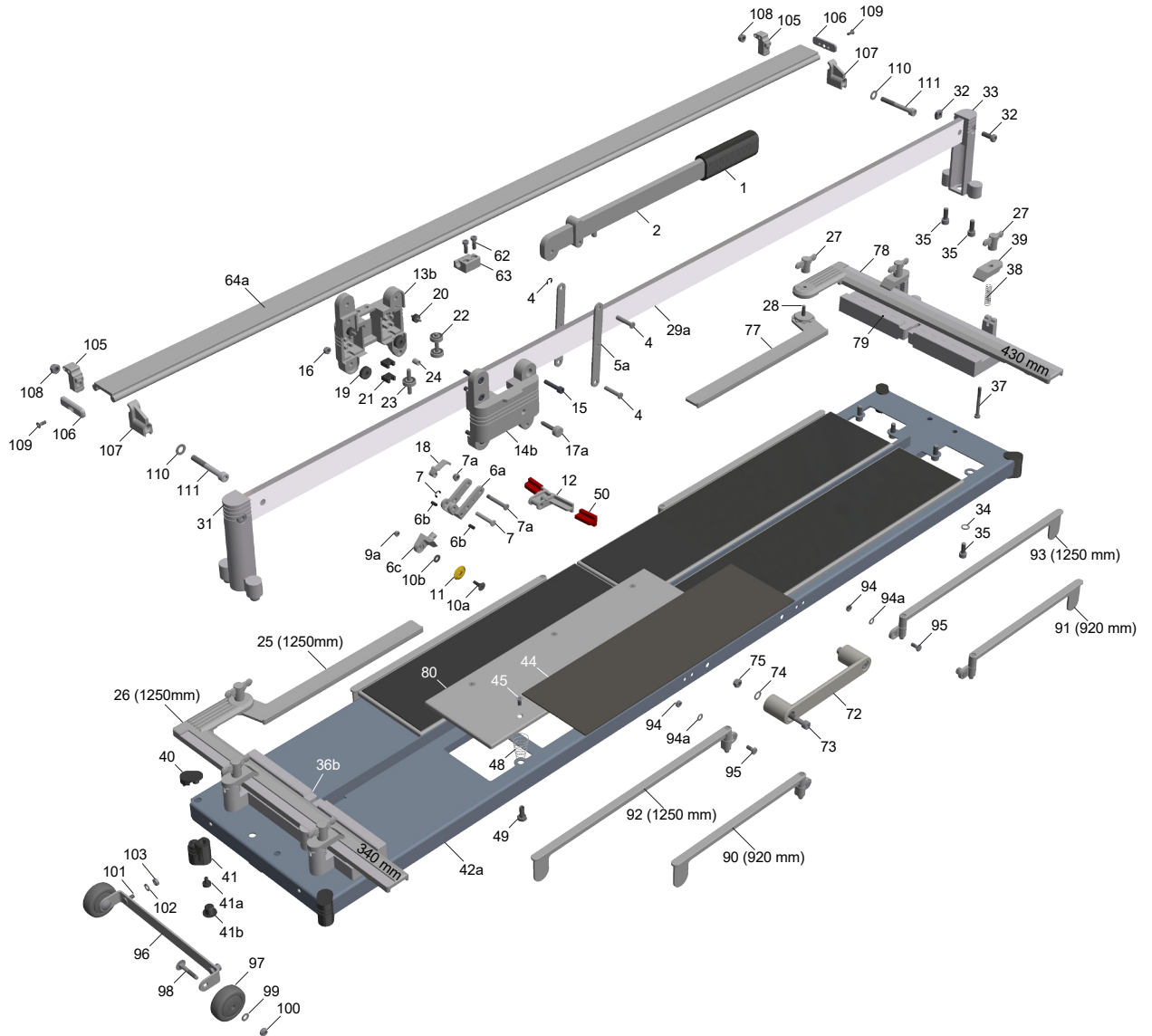



Kaufmann GmbH
Tel. +43 5522 73 822
Fax +43 5522 72 404
www.kaufmann-tools.at
office@kaufmann-tools.at

DE Explosionszeichnung Fliesenschneidmaschine TopLine PRO mit 2 Führungsschienen
Schnittlängen 1550 mm

EN Exploded drawing tile cutting machine TopLine PRO with 2 guide rails
cutting lengths 1550 mm

FR Vue éclatée machine coupe carreaux TopLine PRO avec 2 rails de guidage
longueurs de coupe 1550 mm

EAN-Code
90 02648

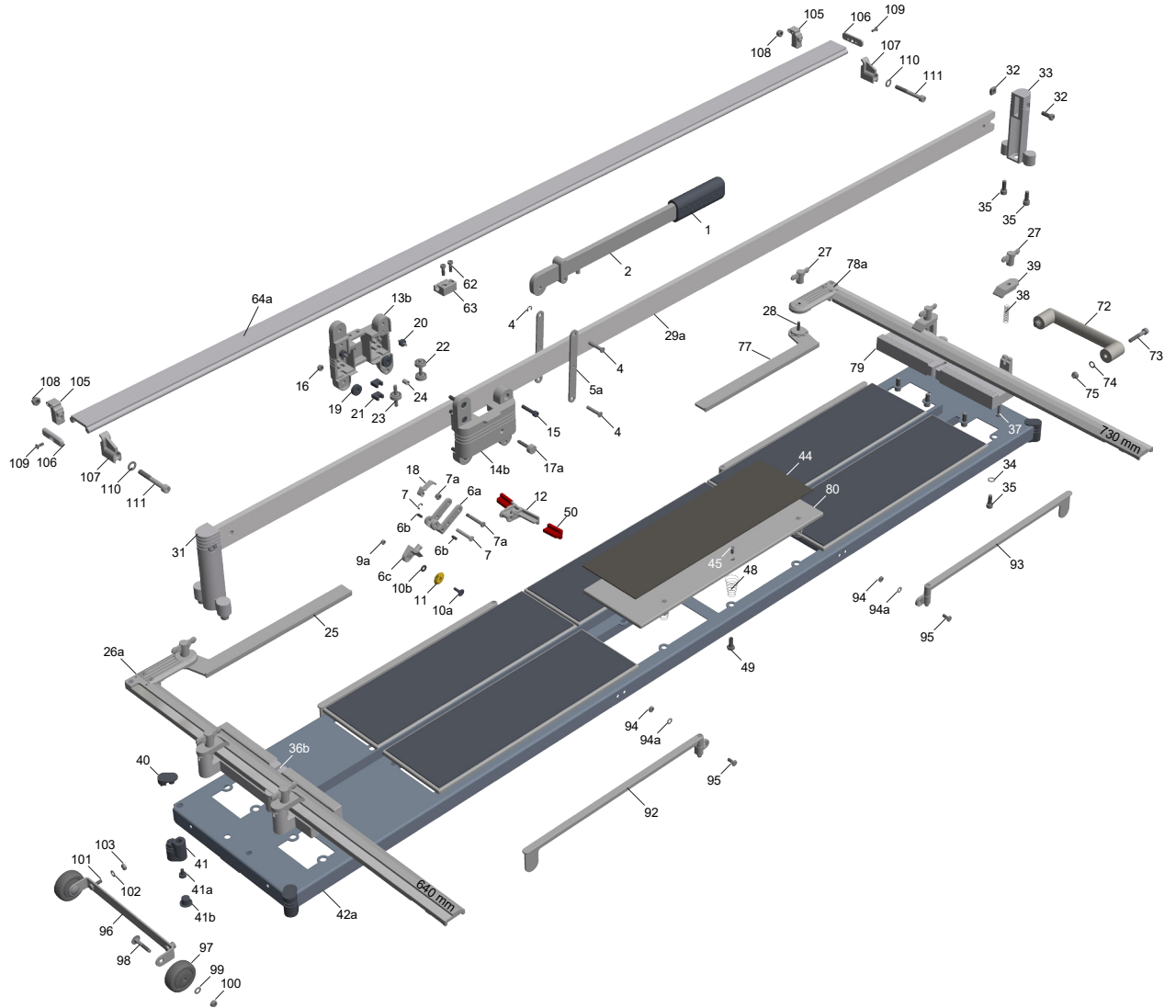



Kaufmann GmbH
Tel. +43 5522 73 822
Fax +43 5522 72 404
www.kaufmann-tools.at
office@kaufmann-tools.at

DE Explosionszeichnung Fliesenschneidmaschine TopLine PRO mit 2 langen Anschlagwinkeln
Schnittlänge 1830 mm

EN Exploded drawing tile cutting machine TopLine PRO with 2 long angles
cutting length 1830 mm

FR Vue éclatée machine coupe carreaux TopLine PRO avec 2 équerres longues
longueur de coupe 1830 mm

EAN-Code
90 02648

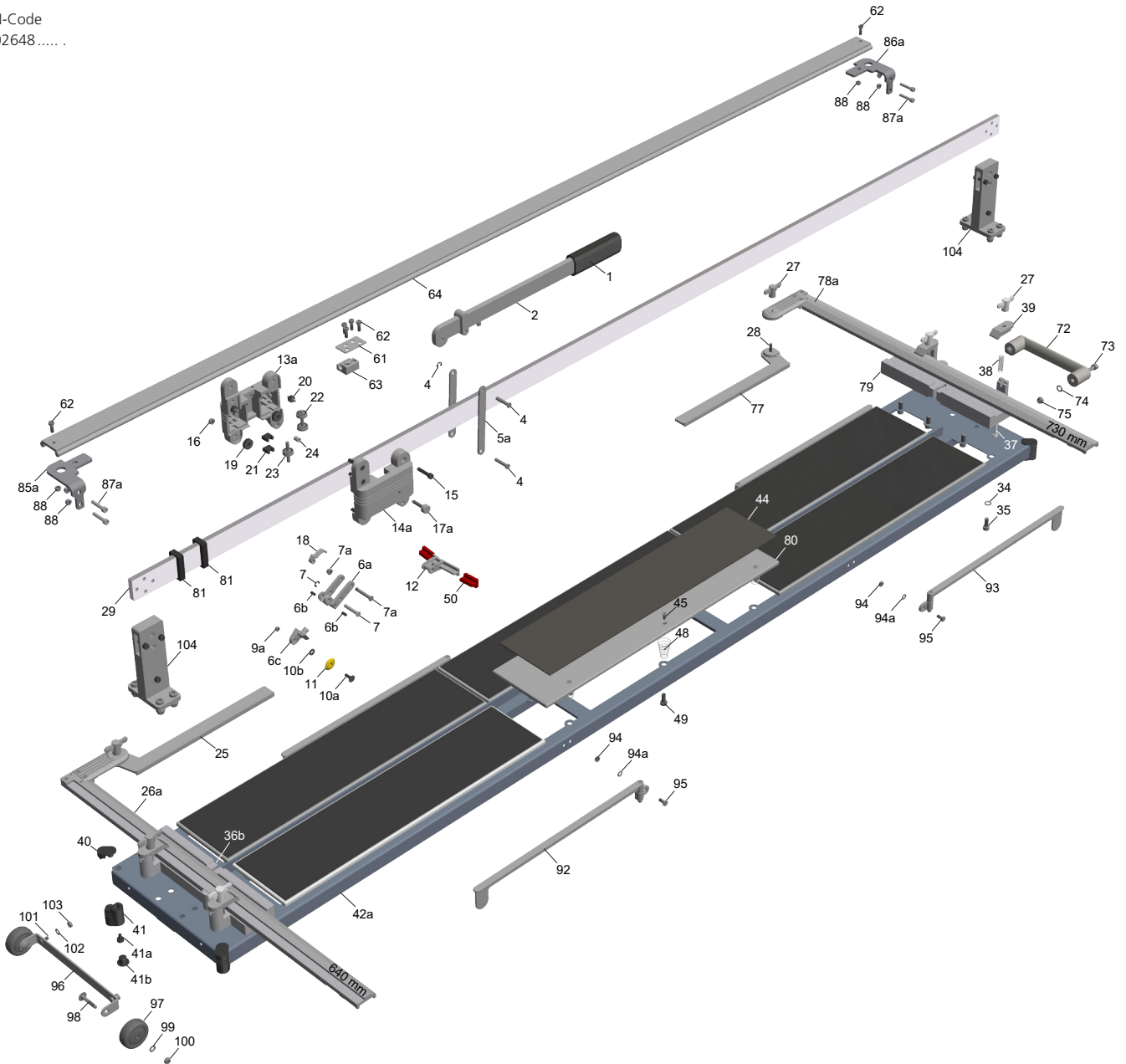



Kaufmann GmbH
Tel. +43 5522 73 822
Fax +43 5522 72 404
www.kaufmann-tools.at
office@kaufmann-tools.at

EAN-Code
90 02648

DE Explosionszeichnung Fliesenschneidmaschine SuperLine

Schnittlängen 630 mm, 920 mm

EN Exploded drawing tile cutting machine SuperLine

cutting lengths 630 mm, 920 mm

FR Vue éclatée machine coupe carreaux SuperLine

longueurs de coupe 630 mm, 920 mm

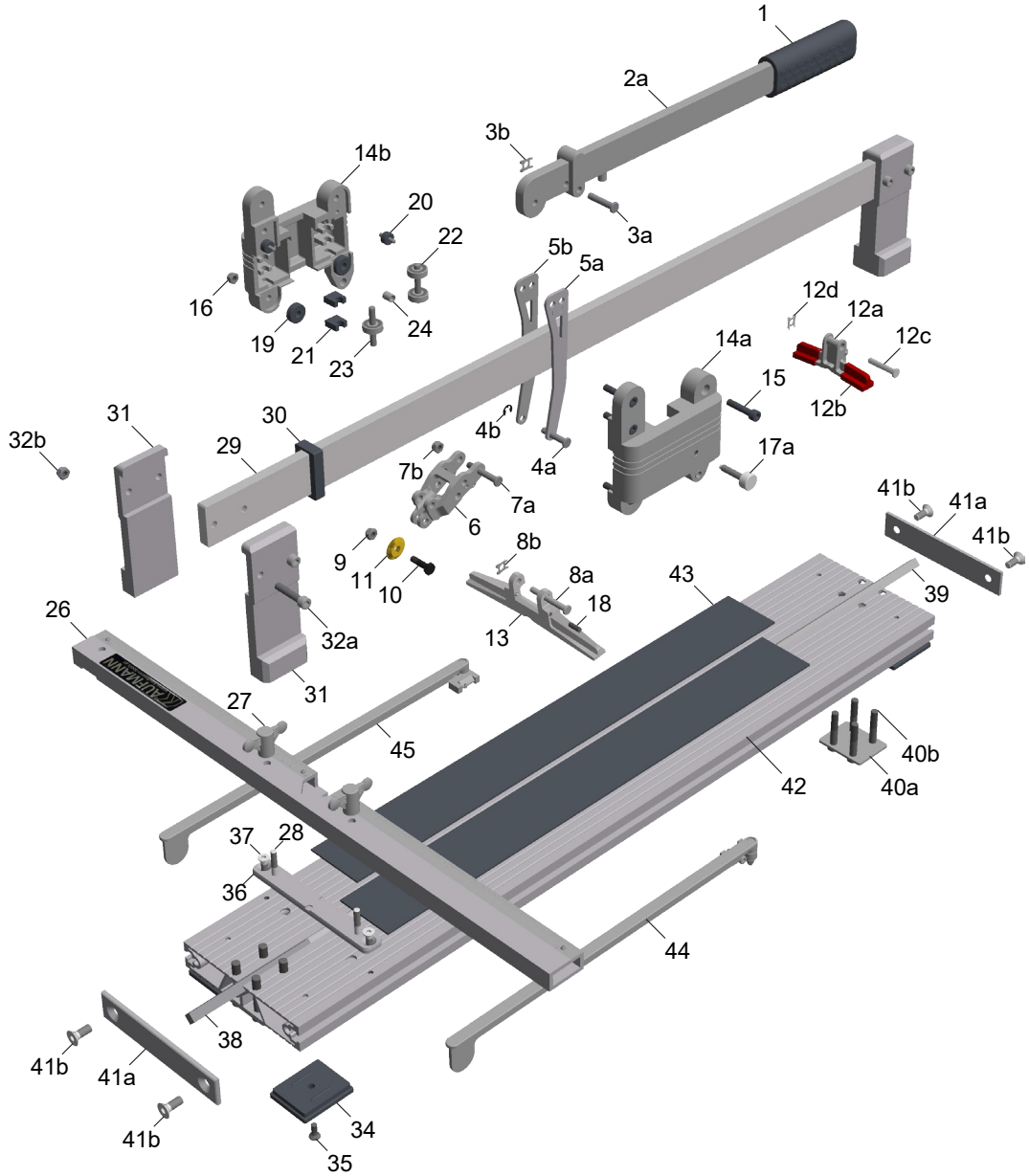



Kaufmann GmbH
Tel. +43 5522 73 822
Fax +43 5522 72 404
www.kaufmann-tools.at
office@kaufmann-tools.at

EAN-Code
90 02648

DE Explosionszeichnung Fliesenschneidmaschine SuperLine
Schnittlängen 1250 mm

EN Exploded drawing tile cutting machine SuperLine
cutting lengths 1250 mm

FR Vue éclatée machine coupe carreaux SuperLine
longueurs de coupe 1250 mm

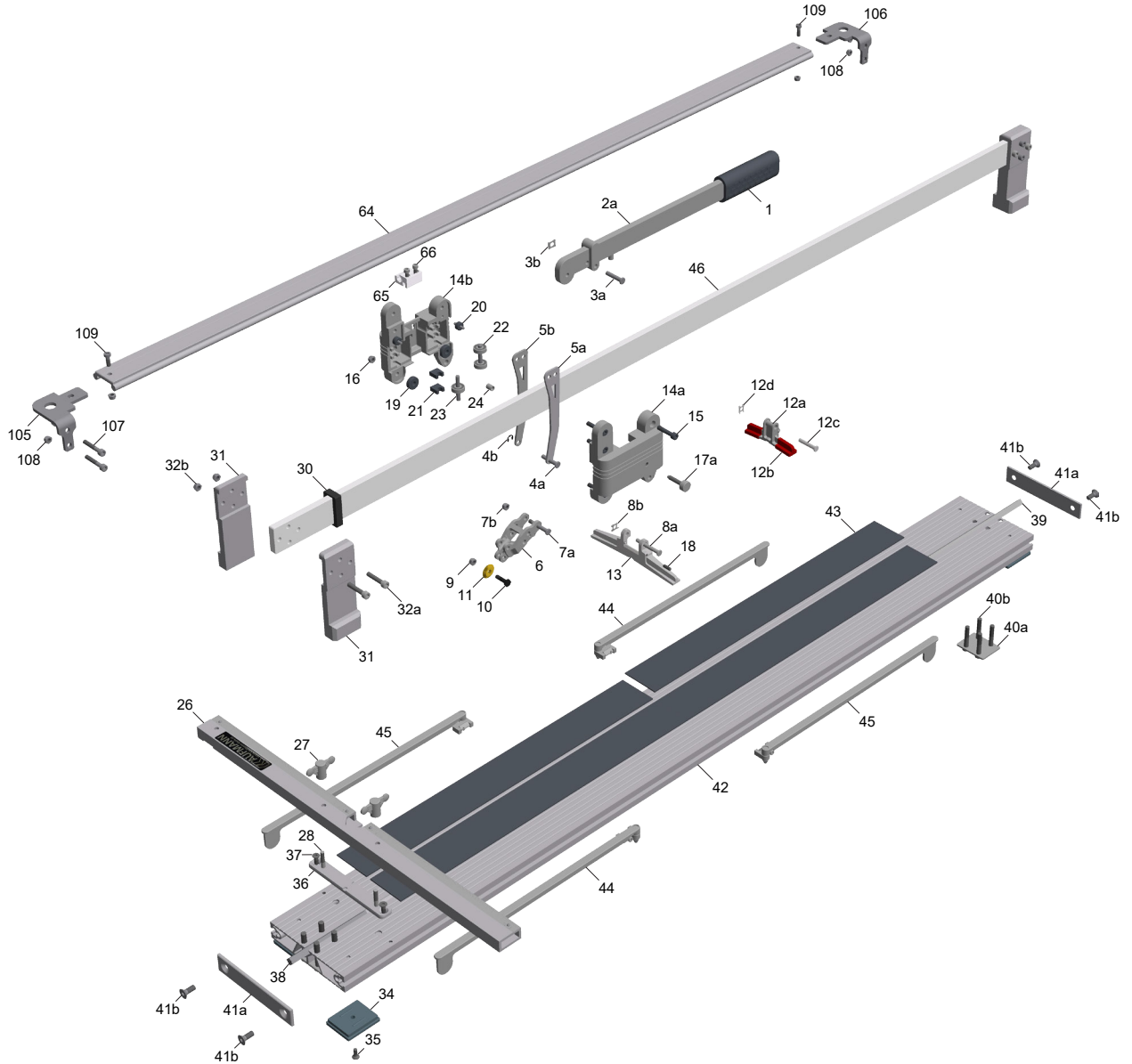



Kaufmann GmbH
Tel. +43 5522 73 822
Fax +43 5522 72 404
www.kaufmann-tools.at
office@kaufmann-tools.at

EAN-Code
90 02648



Kaufmann GmbH, Römerstraße 93, A-6811 Göfis, Tel. +43 5522 73 822, Fax +43 5522 72 404
office@kaufmann-tools.at, www.kaufmann-tools.at

DE Firmendaten

EAN Firmennummer:	90 02648 ...
UID-Nummer:	ATU 41087701
Firmenbuchnummer:	FN 72665k
Firmenbuchgericht:	Landesgericht Feldkirch
Gerichtsstand:	Landesgericht Feldkirch
Kammerzugehörigkeit:	Wirtschaftskammer Vorarlberg / WKÖ
Gründungsjahr:	1957
Eigentum:	100 % Familienbesitz
Qualitätszertifikat:	ÖQUA-Zertifikat («Austria Gütezeichen»)

Technische Änderungen vorbehalten. S.E. & O.
Achtung! Sämtliche Fotos im Katalog haben ausschliesslich Symbolcharakter.

EN Company data

EAN number:	90 02648 ...
VAT-number:	ATU 41087701
Commercial register number:	FN 72665k
Commercial register court:	Regional Court Feldkirch
Place of jurisdiction:	Regional Court Feldkirch
Chamber membership:	Chamber of Commerce Vorarlberg / WKÖ
Year of foundation:	1957
Proprietary:	100 % family property
Certificate of quality:	ÖQUA-certificate («Austria Seal of Quality»)

Technical changes are subject to alteration without notice. S.E. & O.
Attention! All photos in the catalogue are exclusively symbolic.

FR Références

Numéro EAN:	90 02648 ...
Numéro TVA:	ATU 41087701
Numéro registre de commerce:	FN 72665k
Tribunal registre de commerce:	Tribunal de Feldkirch
Tribunal compétent:	Tribunal de Feldkirch
Affiliation à chambre:	Chambre de Commerce Vorarlberg / WKÖ
Année de fondation:	1957
Propriété:	100 % propriété de famille
Certificat de qualité:	Certificat ÖQUA («Label de qualité d'Autriche»)

Sous réserve de changements techniques. S.E. & O.
Attention! Tous les photos du catalogue sont exclusivement symboliques.



Kaufmann GmbH
 Tel. +43 5522 73 822
 Fax +43 5522 72 404
 www.kaufmann-tools.at
 office@kaufmann-tools.at

EAN-Code
 90 02648

DE Zahnbilder
EN Types of Notches
FR Dentures

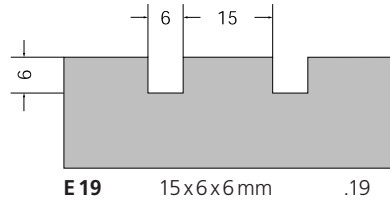
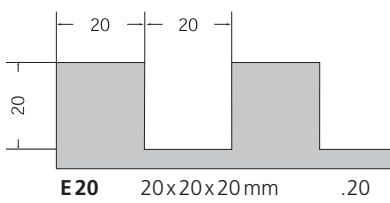
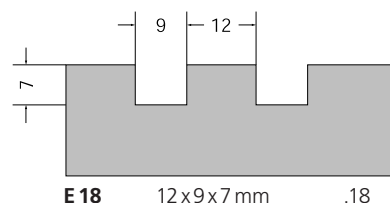
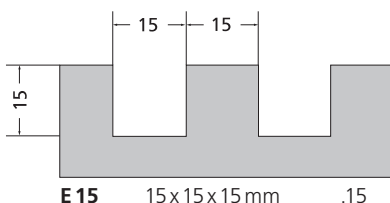
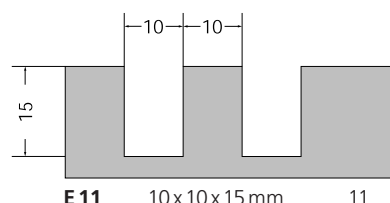
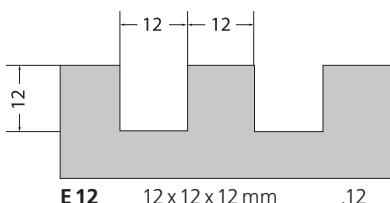
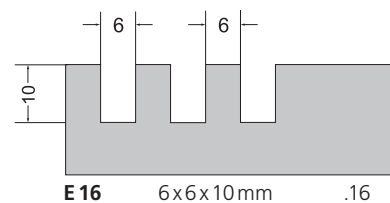
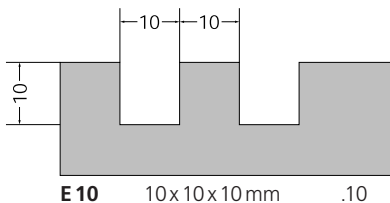
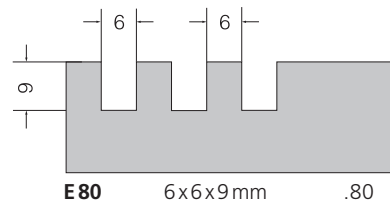
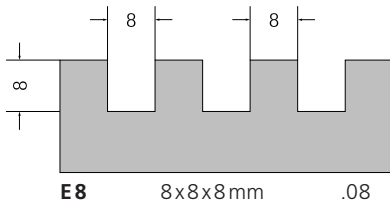
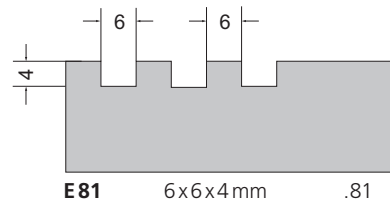
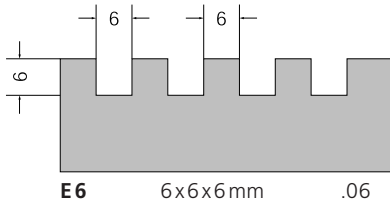
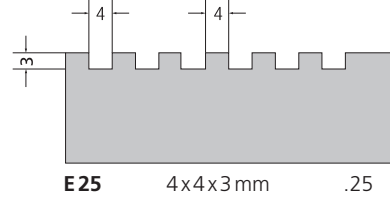
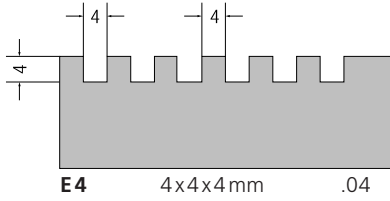
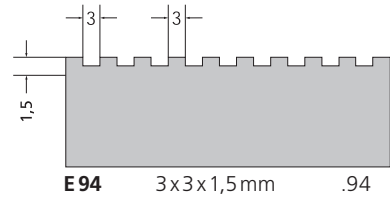
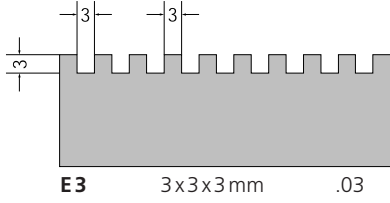



Kaufmann GmbH
 Tel. +43 5522 73 822
 Fax +43 5522 72 404
 www.kaufmann-tools.at
 office@kaufmann-tools.at

EAN-Code
 90 02648

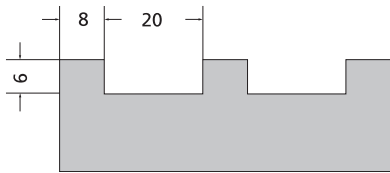

E89 8x20x6mm .89

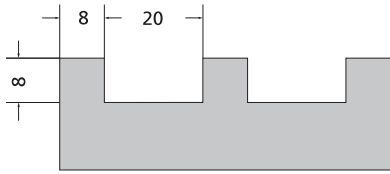

E90 8x20x8mm .90

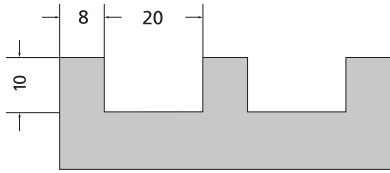

E82 8x20x10mm .82

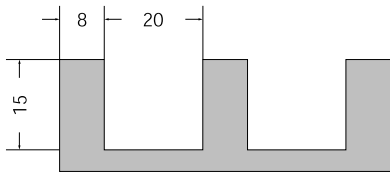

E21 8x20x15mm .21

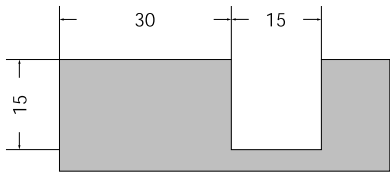

E22 30x15x15mm .22

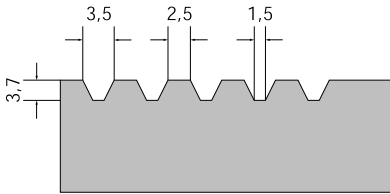

T3 2,5x3,5/1,5x3,7mm .37

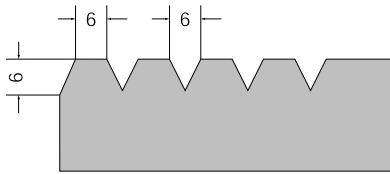

T6 6x6x6mm .39

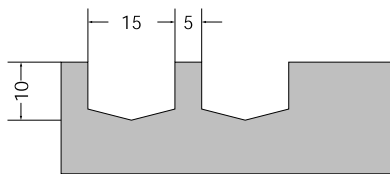

T7 5x15x10mm .40

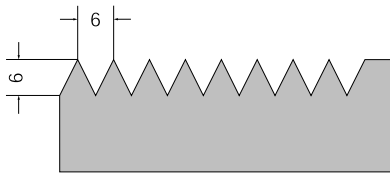

S6 6x6mm .26

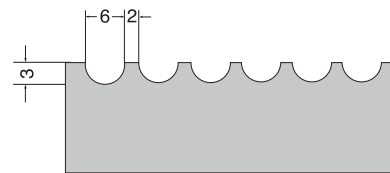

KR6 2x6x3mm .85

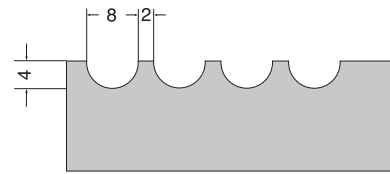

KR8 2x8x4mm .86

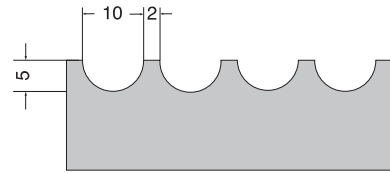

KR10 2x10x5mm .87

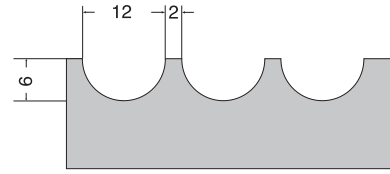

KR12 2x12x6mm .88

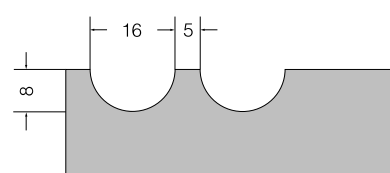

R16 5x16x8mm .61

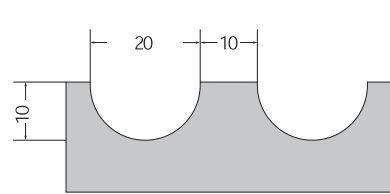

R10 10x20x10mm .51

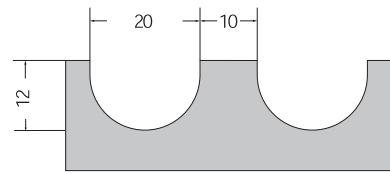

R12 10x20x12mm .54

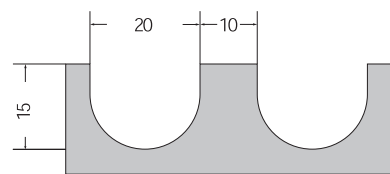

R15 10x20x15mm .52

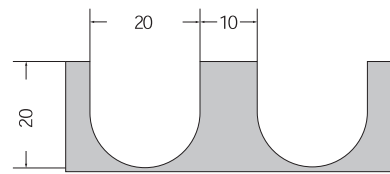

R20 10x20x20mm .53